



MACHINING



Turning & Milling

Best sellers- from training to heavy duty machining

Grinding

Robust, reliable, precise - for repair, production, training and more

Drilling & Sawing

For every job the right machine

Services

Our qualified service team will gladly assist you with an installation and training for your new machine!
We put your machine into operation and instruct your employees - worldwide!

Assembly and Start-up Services

Start-up Package

- ✓ **Initial Setup**
Removing transportation locks, assembly of machine components, levelling of the machine tool
- ✓ **Machine Tool Commissioning**
Filling up operating fluids, conducting machine test run
- ✓ **Operator Training**
Training on all machine functions and maintenance

Add-ons

- ✓ **CNC Operator Training**
- ✓ **KNUTH-Protect - Machine Insurance**
- ✓ **First maintenance service**



Maintenance Services

With our preventive maintenance packages, we make sure your machine remains a reliable cornerstone of your production. In addition to the necessary service jobs according to the KNUTH maintenance schedule for the specific machine, our service technician will also provide you with a detailed service protocol containing a condition rating of your machine tool, results of the accuracy tests, and a proposal for further maintenance and repair jobs.

Conventional Machines

- ✓ **Testing of machine function**
- ✓ **Testing of safety features**
- ✓ **Geometric accuracy testing**
- ✓ **Checking all maintenance and wear points**
- ✓ **Service protocol**

CNC Machines

- ✓ **Testing of machine function**
- ✓ **Testing of safety features**
- ✓ **Geometric accuracy testing**
- ✓ **Checking all maintenance and wear points**
- ✓ **Control and software check-up**
- ✓ **Service protocol**

Cutting Machines

- Testing of machine function**
- Testing of safety features**
- Geometric accuracy testing**
- Checking all maintenance and wear points**
- Control and software check-up**
- Pump / laser source / plasma source check-up**
- Service protocol**

Spare Parts

In case of unforeseen emergency situations, you will always have a KNUTH Machine Service available. Our Spare Parts Department at our headquarters in Wasbek keeps more than 10.000 parts in stock at all times.

The KNUTH Service Help Desk is at your side with advice and solutions. They offer technical support by phone or upon agreement in person at your site. Just give us a call or send us an e-mail.

KNUTH Technical Service Help Desk

Tel. +49 4321 609-263 / -273
E-Mail service@knuth.de

KNUTH Spare Parts Service

Tel. +49 4321 609-258 / -265
E-Mail ersatzteile@knuth.de



Machining

Lathes

VDM S Series	4 / 5
DL E Heavy Series	6 / 7
DL S Series	8 / 9
Sinus D Series	10 / 11
Turnado PRO Series	12 / 13
Turnado Series	14 / 15
V-Turn 410 PRO	16 / 17
V-Turn Series	18 / 19
Basic 180 V	20 / 21
Basic 180 Super	22 / 23
Basic 170 Super PRO	24 / 25
Basic 170 Super	26 / 27
Basic Plus	28 / 29

Drilling Machines

R-VT PRO Series	62 / 63
R-V Serie	64 / 65
R 32 Basic	66 / 67
KSR 50 VT	68 / 69
SSB 70 Xn Advanced	70 / 71
SSB F 60 Super VT PRO	72 / 73
SSB F Super VT Series	74 / 75
SSB Xn Serie	76 / 77
KB 32 SFV PRO	78 / 79
KB 32 SF	80 / 81
TSB Series	82 / 83
KB 20 SV	84 / 85

Milling Machines

BO 110	32 / 33
BO 130	34 / 35
Servomill® UWF Serie	36 / 37
UWF 6	38 / 39
UWF 5	40 / 41
UWF 3.2	42 / 43
Servomill® FPK Series	44 / 45
FPK 4.3 • FPK 6.3 Series	46 / 47
MF 5 VP	48 / 49
VHF 3.2	50 / 51
VHF 2.2	52 / 53
VHF 1.1	54 / 55
SBF 40 TV 1000	56 / 57
Mark Super Series	58 / 59

Band and Circular Saws

ABS S NC Series	88 / 89
ABS L Series	90 / 91
ABS 350 C	92 / 93
ABS 320 PLC	94 / 95
HB L Series	96 / 97
HB 320 BS	98 / 99
SBS Series	100 / 101
HB 250 A	102 / 103
B 200 S	104 / 105
VB-A Series	106 / 107
KKS T Series	108 / 109

Grinding Machines

Servogrind® RSM NC Series	112 / 113
RSM C Series	114 / 115
RSM A Series	116 / 117
Multi Grind	118 / 119
HFS F NC Series	120 / 121
HFS F Advance Series	122 / 123
FSM 480	124

Turning Accessories



Chucks and Accessories



Lathes use chucks for the clamping of workpieces. Lathe chucks and collet chucks come in various diameters and are available with a cast-iron body for manual operation, or in a steel body for constant speed operation. Many sizes are available in 3-jaw and 4-jaw designs. A firm hold of the workpiece and also precise concentricity are very important properties. Our offer is rounded off with workpiece-specific precision collets and soft lathe jaws. Lathe chucks can be selected specifically for the lathe's mount system, or they can be mounted to the machine via a flange



Machine safety



KNUTH offers universal safety devices and protective guards that can be easily retrofitted on a wide variety of machines. The employer is responsible for ensuring and maintaining safety standard on all machines. This includes preventing intentional or unintentional deterioration of safety features, i.e., when a protective guard has become inadequate or defective, or if it has been removed, it must be replaced promptly. Our retrofit solutions are modern, robust, and easy to install.



Lathe Tool Post

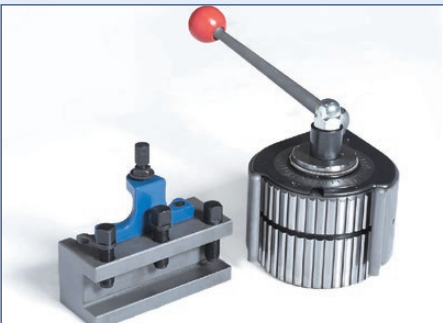

To ensure maximum performance of turning tools, they must be mounted on the machine with high precision and stability. Quick-action tool holders have a proven record in countless applications. Quick-change cartridges hold lathe tools, grooving tools and other turning tools and can be easily repositioned at a certain height or angle at the quick-action tool holder. This allows fast tool changes and a quick set up of new tools.



Digital Linear Scale, Digital Read Out



KNUTH offers position indicators for milling machines, lathes, and grinding machines. KNUTH position indicators feature a robust splash-proof design so they can withstand the harsh conditions in workshop environments.



The new KNUTH Accessory Shop is now live! → [Shop now](#)

Lathes

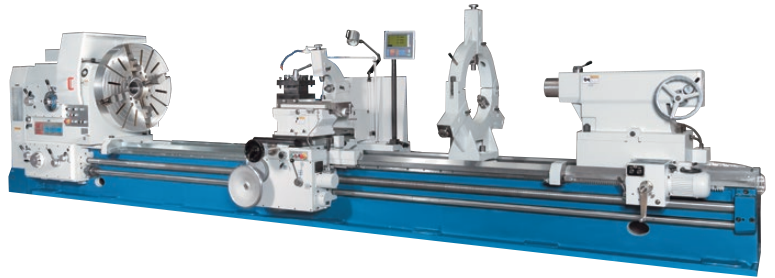

Heavy-Duty Lathes

from Page 4



Engine Lathes

from Page 10



Mechanics Lathes

from Page 20

Conventional Vertical Lathes

VDM S Series

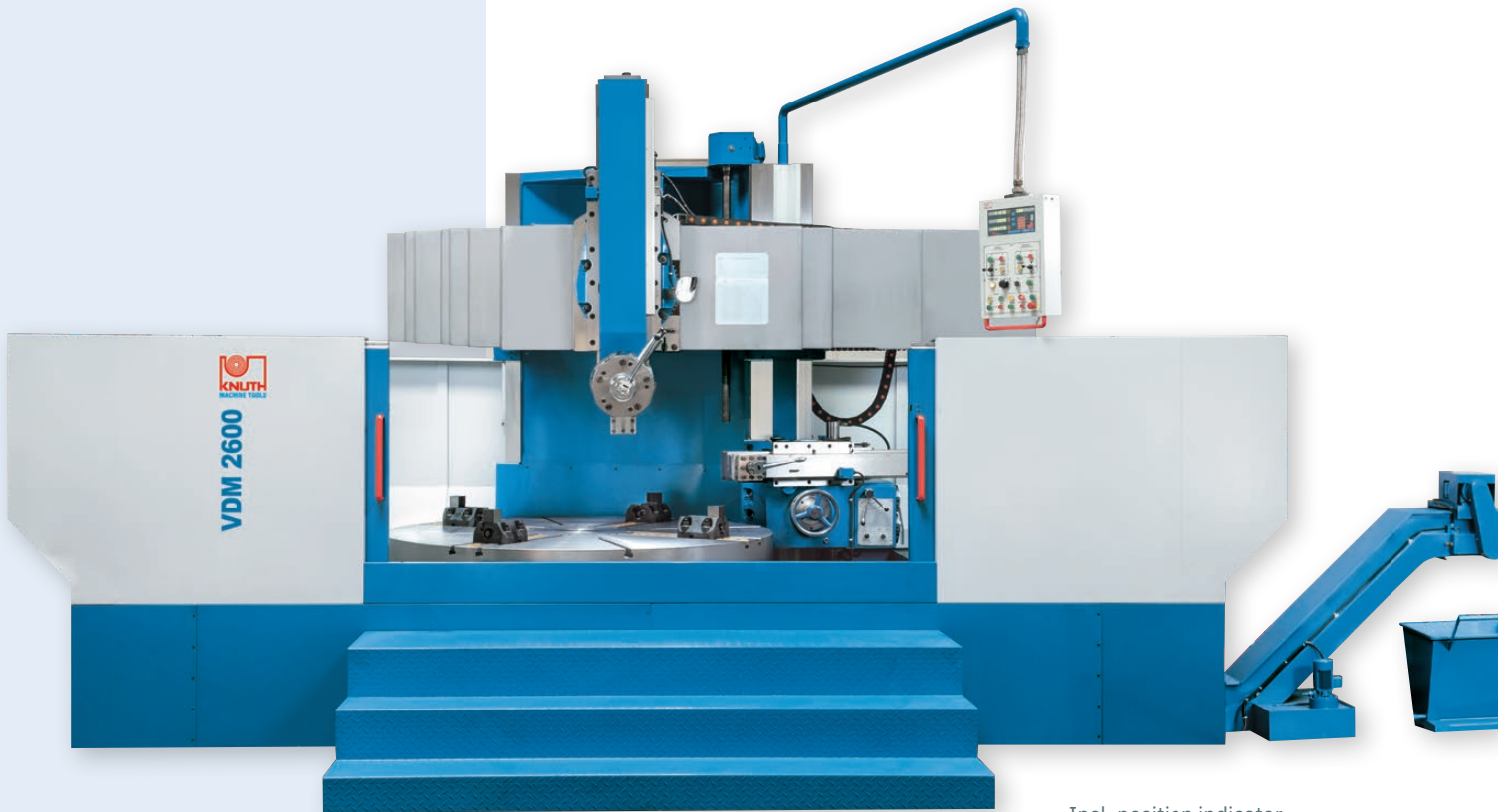

Incl. position indicator



Vertical support includes a 5-station tool holder, side support with independent feed for inside and outside turning

With movable crossbeam, infinitely variable servo feed and additional lateral support for very large turning diameters

- Optimum assembly with crane and forklift
- Infinitely variable feed control via servo motor
- Long, sturdy vertical boom
- Side support with boom and independent feed
- Reduction gear drive for high torque

STANDARD EQUIPMENT

- ✓ 3-axis position indicator X.Pos 3.2
- ✓ Totally enclosed work space
- ✓ Chip conveyor
- ✓ Tool holder vertical
- ✓ Tool holder horizontal
- ✓ Automatic central lubrication
- ✓ Work lamp
- ✓ Anchor bolts
- ✓ Operating tools
- ✓ Operator manual

OPTIONAL EQUIPMENT

- Coolant System 251430
- Coolant Concentrate 5 Ltr. 103184



INFO

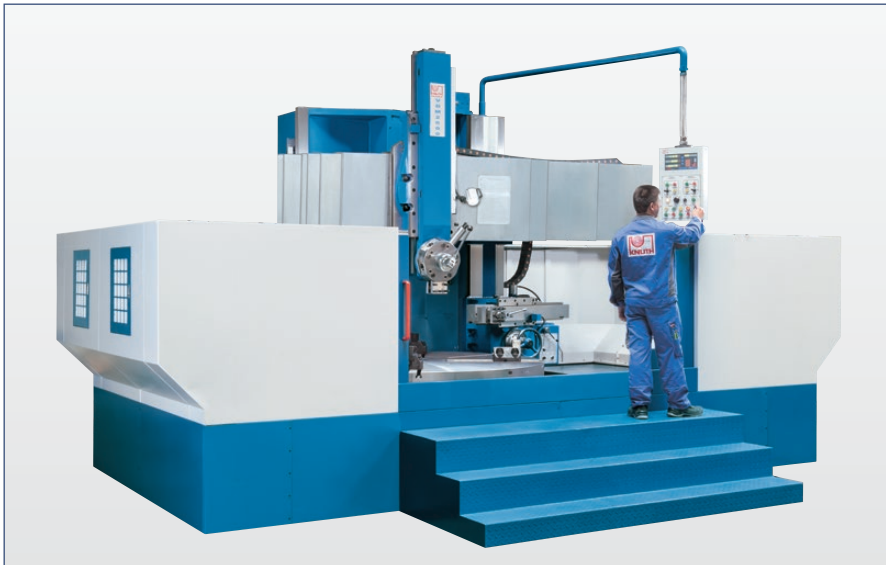

The work area is easily accessible through wide opening doors

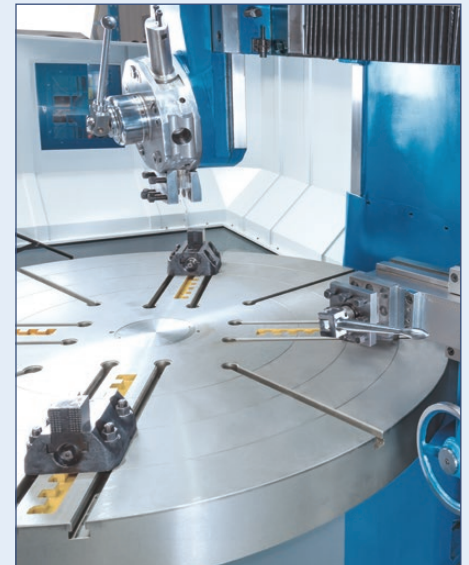

The large turning chuck with stand-up configuration allows for very easy and safe loading and unloading

SPECIFICATIONS

Machine model numbers		1600 S	2600 S
Working area			
Rotating diameter (max.)	mm	1.600	2.600
Turning diameter of upper tool holder	mm	1.600	2.600
Turning diameter of side tool holder	mm	1.400	2.300
Machining height (max.)	mm	1.000	1.500
Swivel range of upper tool holder		± 30°	± 30°
Workpiece length (max.)	mm	1.000	1.500
Workpiece weight (max.)	kg	5.000	10.000
Travels			
Travel X1 axis, upper support	mm	915	1.300
Travel Z1 axis, upper support	mm	800	1.000
Travel W-axis, traverse	mm	650	1.100
Travel X2 axis, side support	mm	630	730
Travel Z2 axis, side support	mm	900	1.180
Headstock			
Speed range	1/min	(16) 5 - 160	(16) 1,4 - 45
Spindle torque (max.)	Nm	25.000	32.000
Rotary table diameter	mm	1.400	2.300
Rapid feed			
Rapid feed of upper support	mm/min	1.800	1.800
Rapid feed of side support	mm/min	1.800	1.800
Feed			
Feed speed X-axis	mm/min	0,8 - 86	0,8 - 86
Feed speed Z-axis	mm/min	0,8 - 86	0,8 - 86
Feed speed W-axis	mm/min	440	440
Tooling			
Tool holder	mm	30x40	30x40
Tool weight max.	kg	50	50
Drive capacity			
Motor rating main drive	kW	30	37
Motor rating X-axis	kW	4,7	4,7
Motor rating Z-axis	kW	4,7	4,7
Measures and weights			
Overall dimensions (L x w x h)	m	6,5x4,2x5,0	7,9x5,3x5,4
Weight	kg	12.500	27.500
Part No.		301393	301396

Conventional Horizontal Lathes

DL E Heavy Series

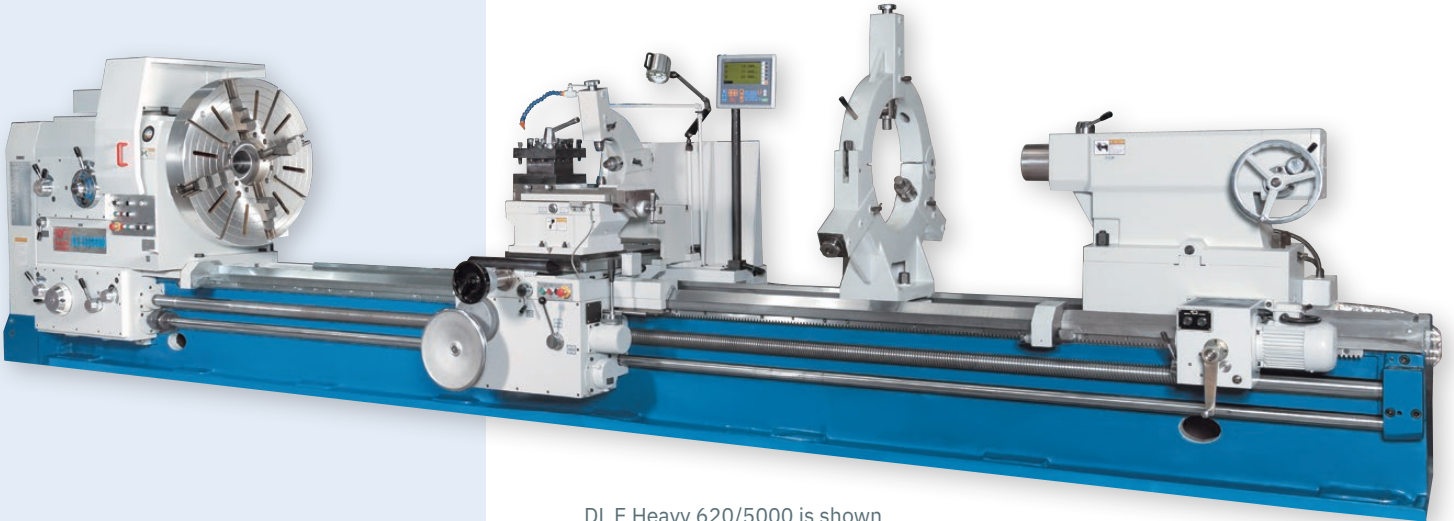

DL E Heavy 620/5000 is shown



21-step gears ensure high torque across the entire precision-stepped speed range starting at 2 rpm.

Conventional high-performance lathe for work requiring large turning diameters and long center distances

- Center widths up to 8000 mm
- Spindle bore of 130 mm
- Powerful motor
- Rapid feed in X and Z directions
- Complete with assembled 3-axis position indicator

STANDARD EQUIPMENT

- ✓ 3-axis position indicator X.Pos 3.2
- ✓ 4-jaw face plate chuck Ø 1000 mm
- ✓ Coolant system
- ✓ Follow rest 50-220 mm
- ✓ Steady rest 50-590 mm
- ✓ Motorized tailstock (from 3.000 mm)
- ✓ LED work lamp
- ✓ Center points
- ✓ Reducing sleeve
- ✓ Foundation bolts
- ✓ Central lubrication
- ✓ Operating tools
- ✓ Operator instructions

OPTIONAL EQUIPMENT

- Steady rest 260-900 mm (for 800) 250644
- Follow rest 50-220 mm (for 800) 250643
- Steady rest 500-1100 mm 250646
- Follow rest 50-220 mm 250645
- Steady rest 50-590mm f. 300508 + DL E Heavy 500er 250617
- Steady rest 220-630mm (for 620) 250642



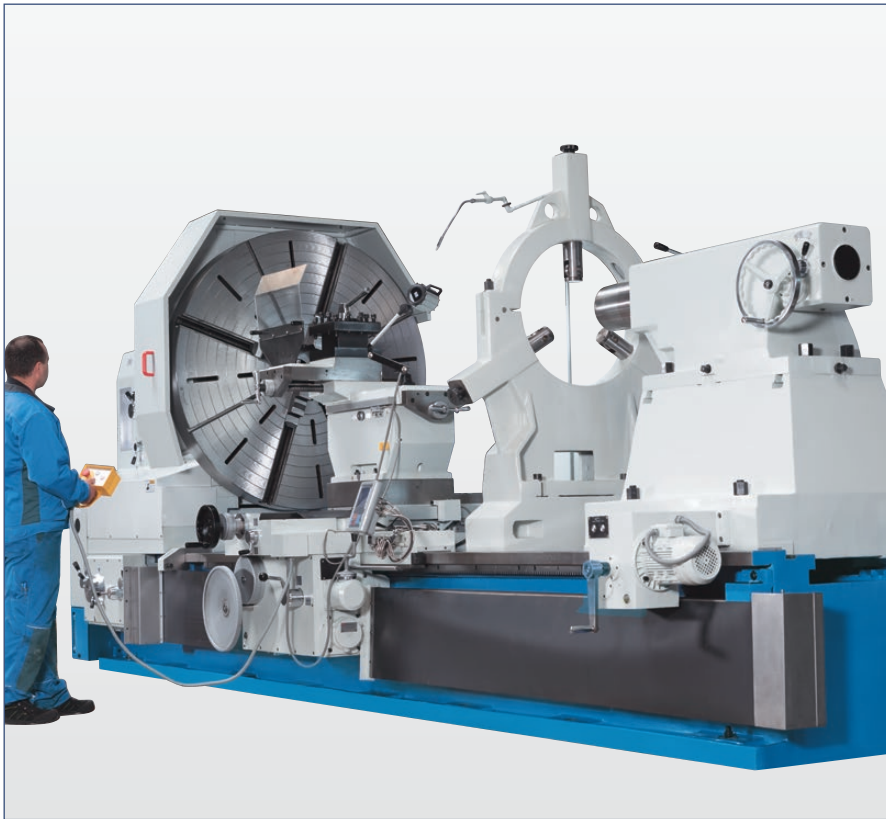

A compact hand-held main spindle control is included to provide full control over the process during complex machining operations



Rests are indispensable when machining long workpieces



Motorized positioning of tailstock (all models with a minimum center width of 3000 mm)

SPECIFICATIONS

Machine model numbers		620/1500	620/3000	620/5000	620/8000	800/3000	800/5000	800/8000
Working area								
Workpiece length (max.)	mm	1.500	3.000	5.000	8.000	3.000	5.000	8.000
Turning diameter over bed	mm	1.250	1.250	1.250	1.250	1.600	1.600	1.600
Turning-Ø over support	mm	900	900	900	900	1.280	1.280	1.280
Travels								
Travel Z-axis	mm	1.300	2.800	4.800	7.800	2.800	4.800	7.800
Travel Z1-axis	mm	300	300	300	300	200	200	200
Headstock								
Spindle speeds (right)	1/min	(21) 3,15 - 315	(21) 3,15 - 315	(21) 3,15 - 315	(21) 3,15 - 315	(21) 2,5 - 250	(21) 2,5 - 250	(21) 2,5 - 250
Spindle bore	mm	130	130	130	130	130	130	130
Spindle mount		ISO A2-15	ISO A2-15	ISO A2-15	ISO A2-15	ISO A2-15	ISO A2-15	ISO A2-15
Rapid feed								
Rapid feed Z-axis	mm/min	3.740	3.740	3.740	3.740	3.740	3.740	3.740
Feed								
Feed X-axis	mm/U	0,064 - 12	0,064 - 12	0,064 - 12	0,064 - 12	0,064 - 12	0,064 - 12	0,064 - 12
Feed Z-axis	mm/U	0,032 - 6	0,032 - 6	0,032 - 6	0,032 - 6	0,032 - 6	0,032 - 6	0,032 - 6
Threading								
Threading, metric	mm	(45) 1 - 120	(45) 1 - 120	(45) 1 - 120	(45) 1 - 120	(45) 1 - 120	(45) 1 - 120	(45) 1 - 120
Threading, diametric	DP	(42) 30 - 1/4	(42) 30 - 1/4	(42) 30 - 1/4	(42) 30 - 1/4	(42) 30 - 1/4	(42) 30 - 1/4	(42) 30 - 1/4
Threading, module	mm	(46) 0,5 - 60	(46) 0,5 - 60	(46) 0,5 - 60	(46) 0,5 - 60	(46) 0,5 - 60	(46) 0,5 - 60	(46) 0,5 - 60
Threading, whitworth	TPI	(48) 0,5 - 60	(48) 0,5 - 60	(48) 0,5 - 60	(48) 0,5 - 60	(48) 0,5 - 60	(48) 0,5 - 60	(48) 0,5 - 60
Tailstock								
Tailstock quill taper		metrisch 80	metrisch 80	metrisch 80	metrisch 80	metrisch 80	metrisch 80	metrisch 80
Tailstock quill stroke	mm	300	300	300	300	300	300	300
Drive capacity								
Motor rating main drive	kW	22	22	22	22	22	22	22
Measures and weights								
Overall dimensions (l x w x h)	m	4,6x1,81 x1,79	6,1x1,88 x1,92	8,1x1,88 1,92	11,1x1,88 x1,92	6,04x2,06 x2,23	8,04x2,06 x2,23	11,04x2,06 x2,23
Weight	kg	9.750	11.550	13.300	16.800	12.900	16.200	21.020
Part No.		300505	300506	300508	300510	300512	300514	300516

Conventional Horizontal Lathes

DL S Series

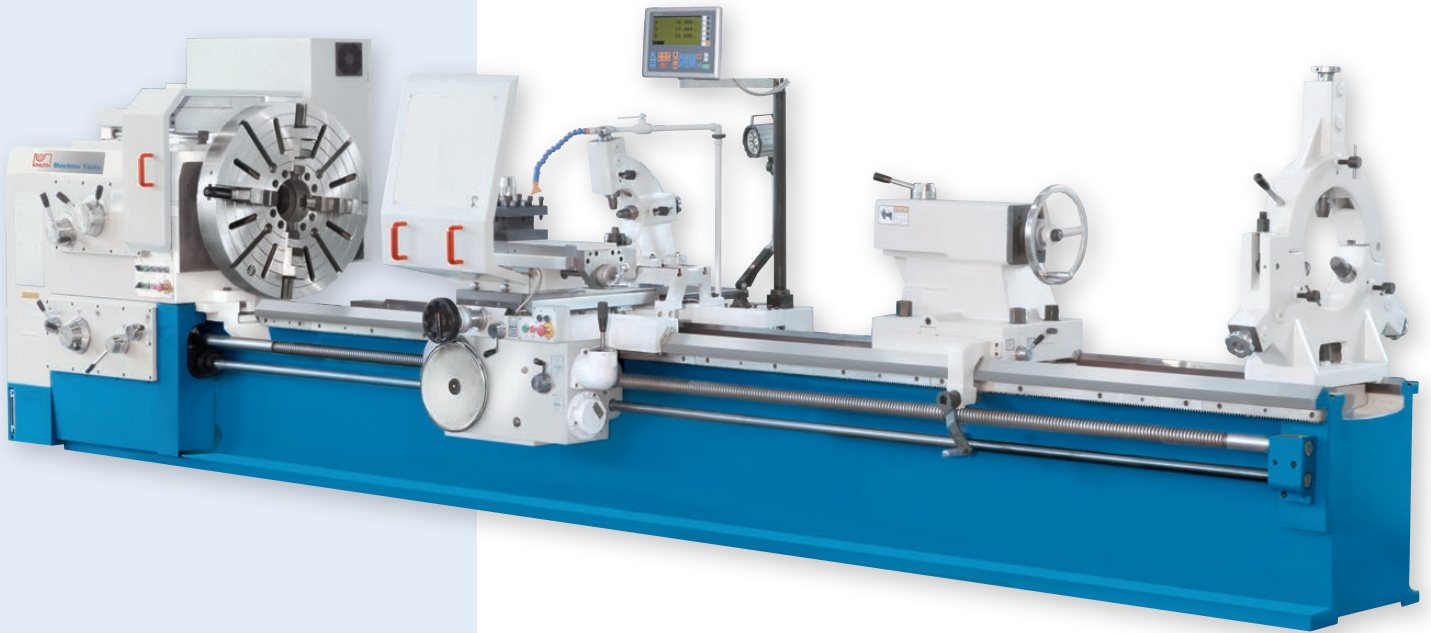

For quick positioning and reduced down-times, the support is equipped with a rapid feed on X and Z

Designed for large workpieces, with a powerful motor and with a rapid feed on X and Z axes

- Center widths up to 5000 mm
- Spindle bore of 100 mm
- Powerful motor
- Spindle speed can be adjusted in 4 steps
- Rapid feed in X and Z direction
- Complete with assembled 3-axis position indicator

STANDARD EQUIPMENT

- ✓ 3-axis position indicator X.Pos 3.2
- ✓ 4-jaw face plate chuck Ø 1000 mm
- ✓ 4-station tool holder
- ✓ Steady rest 40-350 mm
- ✓ Follow rest 30-120 mm
- ✓ Dead centers
- ✓ Reducing sleeve
- ✓ Chuck guard
- ✓ Protective shield for the toolpost,
- ✓ Coolant system
- ✓ Foundation bolts
- ✓ Work lamp
- ✓ Operating tools
- ✓ Operator instructions

OPTIONAL EQUIPMENT

- Motorized tailstock movement 251157
- Rest (100 - 520 mm) 251156
- Steady rest (300 - 720 mm) 251160
- Motorized tailstock movement 251161
- 3-jaw chuck (500 mm) 251162
- Coolant Concentrate 5 Ltr. 103184



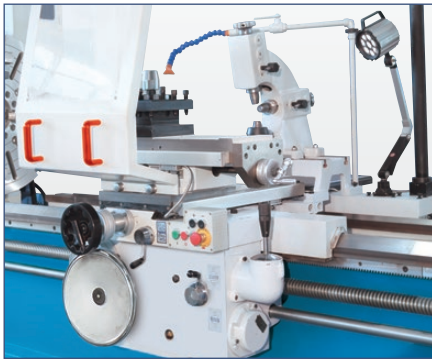

Switches are provided at the support to simplify operation



Support and top slide are designed for high cutting forces

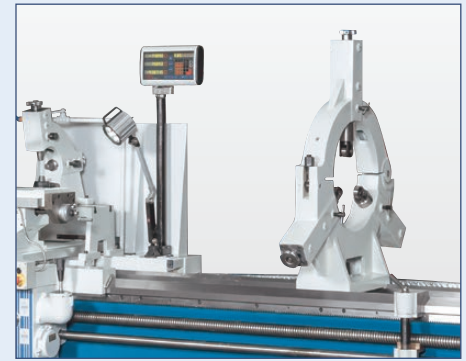

Rigid rests are included in the machine's standard equipment

SPECIFICATIONS

Machine model numbers		515/1500	515/3000	515/4000	515/5000
Working area					
Workpiece length (max.)	mm	1.500	3.000	4.000	5.000
Turning diameter over bed	mm	1.000	1.000	1.000	1.000
Turning-Ø over support	mm	720	720	720	720
Turning diameter over gap bridge	mm	1.350	1.350	1.350	1.350
Workpiece weight (max.)	kg	4.000	4.000	4.000	4.000
Gap bridge length	mm	470	470	470	470
Bed width	mm	600	600	600	600
Travels					
Travel X-axis	mm	520	520	520	520
Travel Z-axis	mm	1.200	2.700	3.700	4.700
Travel Z1-axis	mm	250	250	250	250
Swing range of top slide		90°	90°	90°	90°
Headstock					
Spindle speed	1/min	5 - 630	5 - 630	5 - 630	5 - 630
Spindle bore	mm	100	100	100	100
Spindle mount		A2-11	A2-11	A2-11	A2-11
Rapid feed					
Rapid feed X-axis	mm/min	1.800	1.800	1.800	1.800
Rapid feed Z-axis	mm/min	3.640	3.640	3.640	3.640
Feed					
Feed speed X-axis	mm/min	(64) 0,04 - 4,8	(64) 0,04 - 4,8	(64) 0,04 - 4,8	(64) 0,04 - 4,8
Feed speed Z-axis	mm/min	(64) 0,08 - 9,6	(64) 0,08 - 9,6	(64) 0,08 - 9,6	(64) 0,08 - 9,6
Feed speed Z1-axis	mm/min	(64) 0,02 - 2,4	(64) 0,02 - 2,4	(64) 0,02 - 2,4	(64) 0,02 - 2,4
Tooling					
Tool shank dimensions	mm	32x32	32x32	32x32	32x32
Threading					
Threading, metric	mm	(53) 1-120	(53) 1-120	(53) 1-120	(53) 1-120
Threading - inch		(49) 30 - 1/4	(49) 30 - 1/4	(49) 30 - 1/4	(49) 30 - 1/4
Threading, diametric	DP	(56) 60-0,5	(56) 60-0,5	(56) 60-0,5	(56) 60-0,5
Threading, module	mm	(54) 0,5 - 60	(54) 0,5 - 60	(54) 0,5 - 60	(54) 0,5 - 60
Tailstock					
Tailstock quill diameter	mm	120	120	120	120
Tailstock taper	MT	6	6	6	6
Tailstock quill stroke	mm	250	250	250	250
Drive capacity					
Motor rating main drive	kW	22	22	22	22
Motor rating coolant pump	kW	0,15	0,15	0,15	0,15
Motor rating feed	kW	1,1	1,1	1,1	1,1
Total power consumption	kVA	23	23	23	23
Measures and weights					
Overall dimensions (L x w x h)	m	3,65x1,5x1,6	5,15x1,5x1,6	6,15x1,5x1,6	7,15x1,5x1,6
Weight	kg	5.600	6.800	8.400	9.500
Part No.		301514	301515	301516	301517

Conventional Horizontal Lathes

Sinus D Series

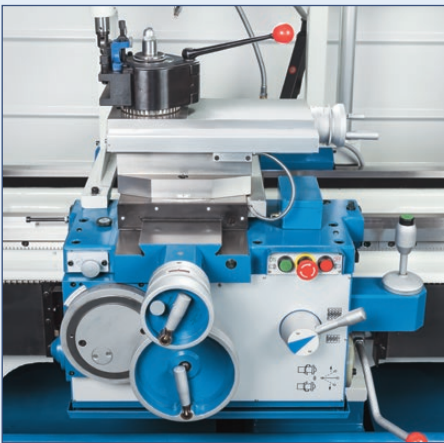
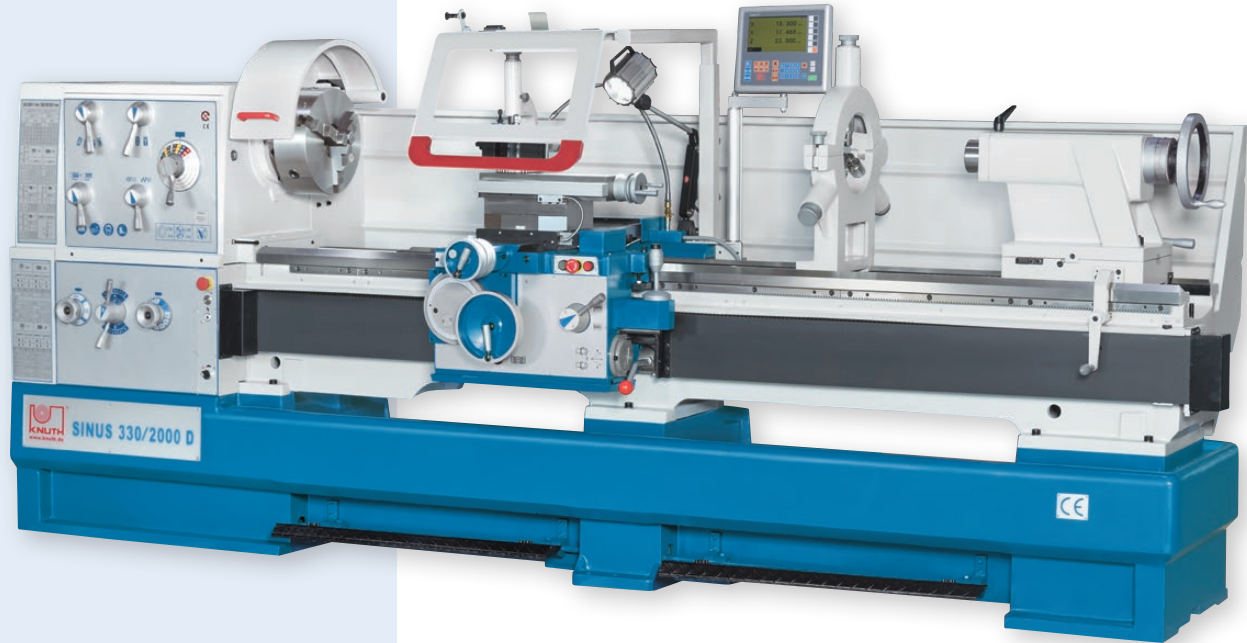

Support moves in linear and cross direction via rapid feed

Classic design with extensive standard equipment, including 3 axis read out, and taper turning

- One-piece heavy-duty cast bed for increased rigidity
- Sturdy headstock design with large spindle bearings
- Rapid feed on 2 axes for fast positioning
- Taper turning attachment for additional applications
- Well-designed safety functions

STANDARD EQUIPMENT

- ✓ 3-axis position indicator X.Pos 3.2
- ✓ 3-jaw chuck
- ✓ 4-jaw face plate chuck
- ✓ Face plate
- ✓ Dog plate
- ✓ Quick tool changer head
- ✓ Quick change tool holder
- ✓ Fixed splash guard (wall)
- ✓ Coolant system
- ✓ Steady and follow rests
- ✓ Taper turning unit
- ✓ Chuck guard
- ✓ LED Work light
- ✓ Reducing sleeve
- ✓ Dead center
- ✓ Rapid feed on Z and X axes
- ✓ Toolbox with operating tools
- ✓ Operator instructions





Rests ensure maximum precision when machining long workpieces

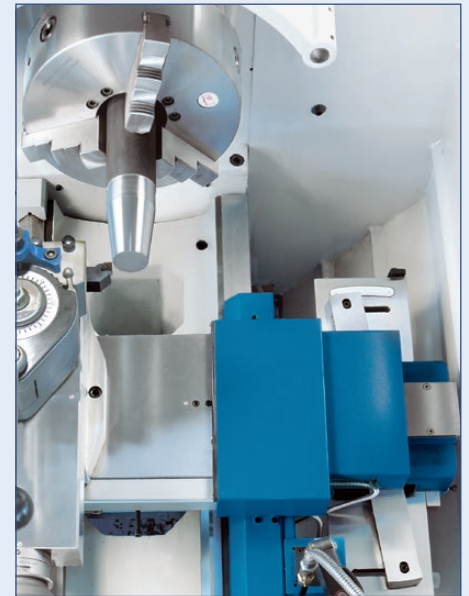

Taper turning unit is included

SPECIFICATIONS

Machine model numbers		330/1500	330/2000	330/3000	400/1500	400/2000	400/3000
Working area							
Workpiece length (max.)	mm	1.500	2.000	3.000	1.500	2.000	3.000
Turning diameter over bed	mm	660	660	660	800	800	800
Turning-Ø over support	mm	440	440	440	570	570	570
Turning diameter without gap bridge	mm	900	900	900	1.035	1.035	1.035
Gap bridge length	mm	320	320	320	330	330	330
Bed width	mm	400	400	400	400	400	400
Travels							
Travel X-axis	mm	368	368	368	420	420	420
Travel Z1-axis	mm	230	230	230	230	230	230
Swing range of top slide		45°	45°	45°	70°	70°	70°
Headstock							
Spindle speed	1/min	(16) 25 - 1.600	(16) 25 - 1.600	(16) 25 - 1.600	(16) 25 - 1.600	(16) 25 - 1.600	(16) 25 - 1.600
Spindle bore	mm	105	105	105	105	105	105
Spindle mount		D1-8	D1-8	D1-8	D1-8	D1-8	D1-8
Spindle taper	mm	∅ 113 / 1:20	∅ 113 / 1:20	∅ 113 / 1:20	∅ 113 / 1:20	∅ 113 / 1:20	∅ 113 / 1:20
Rapid feed							
Rapid feed X-axis	mm/min	2.000	2.000	2.000	2.000	2.000	2.000
Rapid feed Z-axis	mm/min	4.000	4.000	4.000	4.000	4.000	4.000
Feed							
Feed X-axis	mm/U	(25) 0,022 - 0,74	(25) 0,022 - 0,74	(25) 0,022 - 0,74	(25) 0,022 - 0,74	(25) 0,022 - 0,74	(25) 0,022 - 0,74
Feed Z-axis	mm/U	(25) 0,044 - 1,48	(25) 0,044 - 1,48	(25) 0,044 - 1,48	(25) 0,044 - 1,48	(25) 0,044 - 1,48	(25) 0,044 - 1,48
Threading							
Threading, metric	mm	(54) 0,45 - 120	(54) 0,45 - 120	(54) 0,45 - 120	(54) 0,45 - 120	(54) 0,45 - 120	(54) 0,45 - 120
Threading, diametric	DP	(42) 0,88 - 160	(42) 0,88 - 160	(42) 0,88 - 160	(42) 0,88 - 160	(42) 0,88 - 160	(42) 0,88 - 160
Threading, module	mm	(46) 0,25 - 60	(46) 0,25 - 60	(46) 0,25 - 60	(46) 0,25 - 60	(46) 0,25 - 60	(46) 0,25 - 60
Threading, whitworth	TPI	(54) 7/16 - 80	(54) 7/16 - 80	(54) 7/16 - 80	(54) 7/16 - 80	(54) 7/16 - 80	(54) 7/16 - 80
Tailstock							
Tailstock quill diameter	mm	90	90	90	90	90	90
Tailstock taper	MT	5	5	5	5	5	5
Tailstock quill stroke	mm	235	235	235	235	235	235
Tailstock traverse adjustment	mm	± 12,5	± 12,5	± 12,5	± 11	± 11	± 11
Drive capacity							
Motor rating main drive	kW	7,5	7,5	7,5	7,5	7,5	7,5
Measures and weights							
Overall dimensions (l x w x h)	m	3,21x1,23x1,6	3,71x1,23x1,6	4,71x1,23x1,6	3,24x1,14x1,91	3,74x1,14x1,91	4,74x1,14x1,91
Weight	kg	2.800	2.900	3.300	3.220	3.500	3.870
Part No.		300010	300011	300012	300015	300013	300014

Conventional Horizontal Lathes

Turnado PRO Series

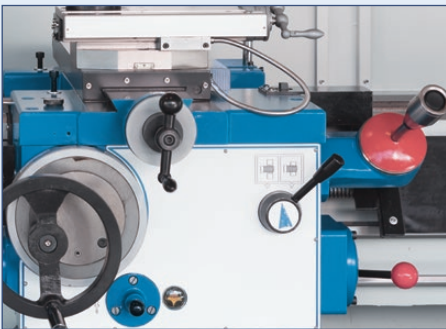

Support moves in linear and cross direction via motorized rapid feed for reduced down-time

Top model of the Turnado series with infinitely variable spindle speed and constant cutting speed, as well as rapid traverse and modern ergonomic design

- Infinitely variable speed range
- Apron with rapid feed motor
- Extensive standard equipment
- Constant cutting speed

STANDARD EQUIPMENT

- | | |
|---|------------------------------------|
| ✓ 3-axis position indicator, X.pos 3.2 VC | ✓ Thread gauge, Reducing sleeve |
| ✓ Quick tool changer head | ✓ Dead center |
| ✓ Quick change tool holder | ✓ Traveling cover for the toolpost |
| ✓ Rapid traverse for X- and Z-axis | ✓ Chuck guard |
| ✓ 3-jaw chuck | ✓ Foot brake pedal |
| ✓ 4-jaw face chuck | ✓ Fixed splash guard (wall) |
| ✓ Face plate | ✓ Work light |
| ✓ Follow and steady rests | ✓ Toolbox with operating tools |
| ✓ Coolant system | ✓ Operator instructions |
| ✓ Micrometer longitudinal stop | |





The tailstock can be repositioning for conical turning



The extensive features of the X.Pos Position Indicator are complemented with a digital speed indicator and an easy to program auxiliary function

SPECIFICATIONS

Machine model numbers		230/1000	230/1500	280/1500
Working area				
Center width	mm	1.000	1.500	1.500
Center height	mm	230	230	280
Turning-Ø over bed	mm	460	460	560
Turning diameter over gap bridge	mm	690	690	785
Turning-Ø over support	mm	274	274	355
Gap bridge length	mm	155	155	170
Bed width	mm	300	300	350
Travels				
Travel X-axis	mm	285	285	316
Travel Z1-axis	mm	128	128	130
Swing range of top slide		± 52°	± 52°	± 52°
Headstock				
Speed range, low	1/min	30 - 600	30 - 600	25 - 200
Speed range, high	1/min	600 - 3.000	600 - 2.300	200 - 1.600
Spindle bore	mm	58	58	80
Spindle mount		Camlock D1-6	Camlock D1-6	Camlock D1-8
Feed				
Feed X-axis	mm/U	0,025 - 1,384	0,025 - 1,384	0,02 - 0,573
Feed Z-axis	mm/U	0,055 - 3,061	0,055 - 3,061	0,059 - 1,646
Threading				
Threading, metric	mm	(41) 0,1 - 14	(41) 0,1 - 14	(41) 0,2 - 14
Threading, diametric	DP	(50) 4-112	(50) 4-112	(50) 4-112
Threading, module	mm	(34) 0,1 - 7	(34) 0,1 - 7	(34) 0,1 - 7
Threading, whitworth	TPI	(60) 2-112	(60) 2-112	(60) 2-112
Tailstock				
Tailstock quill diameter	mm	60	60	75
Tailstock taper		MK 4	MK 4	MK 5
Tailstock quill stroke	mm	120	120	180
Tailstock traverse adjustment	mm	± 13	± 13	± 12
Drive capacity				
Motor rating main drive	kW	7,5	7,5	7,5
Measures and weights				
Overall dimensions (L x w x h)	m	2,2x1,08x1,57	2,75x1,08x1,57	2,84x1,15x1,46
Weight	kg	1.720	1.970	2.370
Part No.		320562	320563	320564

Conventional Horizontal Lathes

Turnado Series

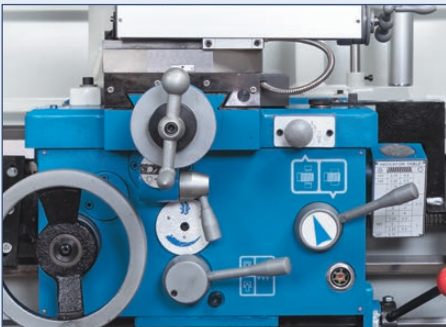
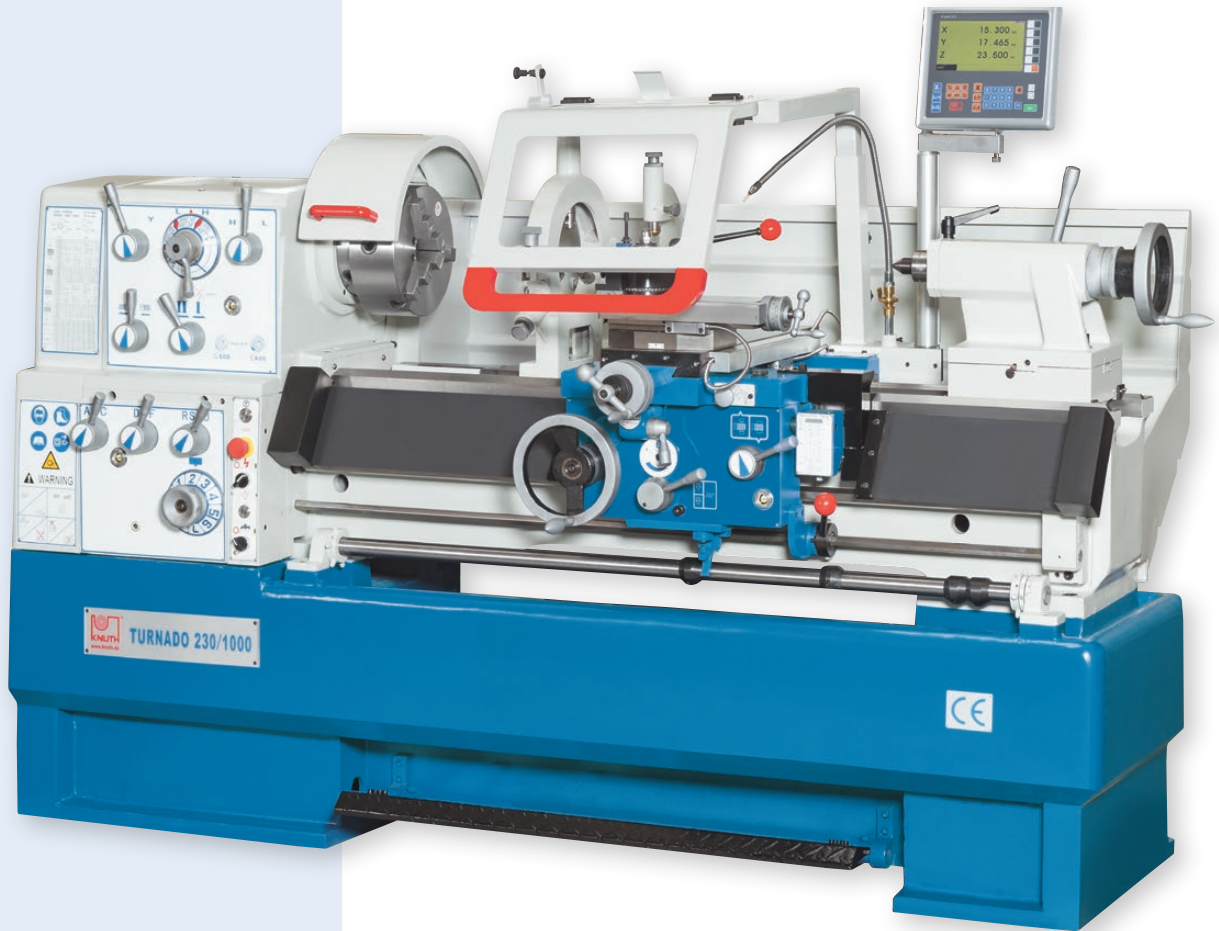

The slip coupling for the automatic feed is positioned centrally on the apron for easy adjustments



Proven classic with extensive standard equipment and powerful motor

- Classic design with sturdy construction
- One-piece heavy cast bed for increased rigidity
- 3-axis position indicator with various turning functions
- Adjustable feed stops for longitudinal feed
- Extensive standard equipment package

STANDARD EQUIPMENT

- | | |
|---------------------------------------|--------------------------------------|
| ✓ 3-axis position indicator X.Pos 3.2 | ✓ Thread gauge |
| ✓ Quick tool changer head | ✓ Reducing sleeve |
| ✓ Quick change tool holder | ✓ Dead center |
| ✓ Adjustable feed stops | ✓ Protective shield for the toolpost |
| ✓ 3-jaw chuck | ✓ Chuck guard |
| ✓ 4-jaw face chuck | ✓ Foot brake pedal |
| ✓ Face plate | ✓ Fixed splash guard (wall) |
| ✓ Follow and steady rests | ✓ Work light |
| ✓ Coolant system | ✓ Toolbox with operating tools |
| ✓ Micrometer longitudinal stop | ✓ Operator instructions |

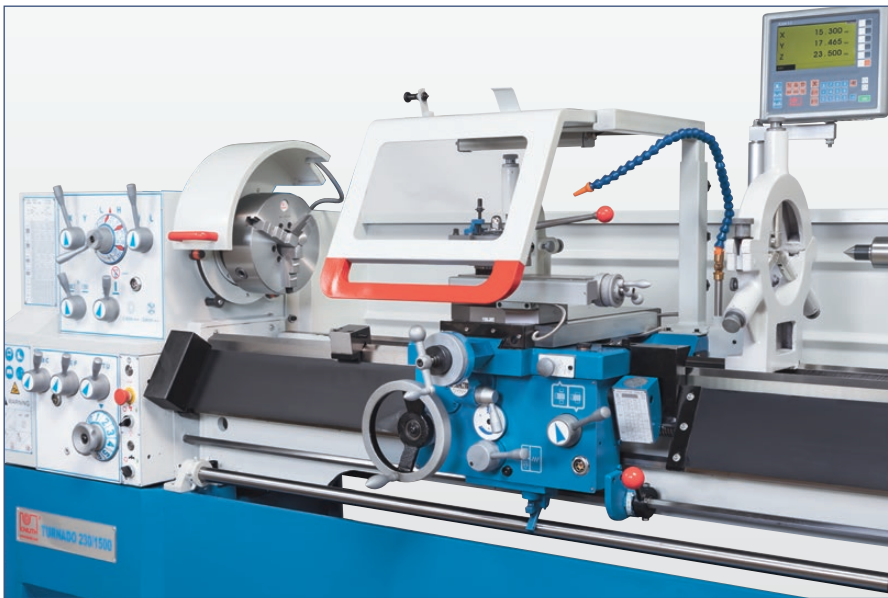

The large, swiveling safety cover at the support protects the user and keeps the work space clean



The user-friendly control panel at the headstock facilitates rapid user familiarization and intuitive operation

SPECIFICATIONS

Machine model numbers		230/1000	230/1500	230/2000	280/1500	280/2000
Working area						
Workpiece length (max.)	mm	1.000	1.500	2.000	1.428	1.928
Turning-Ø over bed	mm	460	460	460	560	560
Turning-Ø over support	mm	274	274	274	355	355
Turning diameter over gap bridge	mm	690	690	690	785	785
Gap bridge length	mm	155	155	155	170	170
Bed width	mm	300	300	300	350	350
Center height	mm	230	230	230	280	280
Travels						
Travel X-axis	mm	285	285	285	316	316
Travel Z1-axis	mm	128	128	128	130	130
Swing range of top slide		± 52°	± 52°	± 52°	± 52°	± 52°
Headstock						
Spindle speeds	1/min	(12) 25 - 2.000	(12) 25 - 2.000	(12) 25 - 2.000	(12) 25 - 1.600	(12) 25 - 1.600
Spindle bore	mm	58	58	58	80	80
Spindle mount		Camlock D1-6	Camlock D1-6	Camlock D1-6	Camlock D1-8	Camlock D1-8
Spindle taper	MT	6	6	6	7	7
Feed						
Feed X-axis	mm/U	0,014 - 0,784	0,014 - 0,784	0,014 - 0,784	0,02 - 0,573	0,02 - 0,573
Feed Z-axis	mm/U	0,031 - 1,7	0,031 - 1,7	0,031 - 1,7	0,059 - 1,646	0,059 - 1,646
Threading						
Threading, metric	mm	(47) 0,1 - 14	(47) 0,1 - 14	(47) 0,1 - 14	(47) 0,2 - 14	(47) 0,2 - 14
Threading, diametric	DP	(50) 4-112	(50) 4-112	(50) 4-112	(50) 4-112	(50) 4-112
Threading, module	mm	(39) 0,1 - 7	(39) 0,1 - 7	(39) 0,1 - 7	(39) 0,1 - 7	(39) 0,1 - 7
Threading, whitworth	TPI	(60) 2-112	(60) 2-112	(60) 2-112	(60) 2-112	(60) 2-112
Tailstock						
Tailstock quill diameter	mm	60	60	60	75	75
Tailstock taper	MK	4	4	4	5	5
Tailstock quill stroke	mm	120	120	120	180	180
Tailstock traverse adjustment	mm	± 13	± 13	± 13	± 12	± 12
Drive capacity						
Motor rating main drive	kW	5,5	5,5	5,5	7,5	7,5
Measures and weights						
Overall dimensions (L x w x h)	m	2,2x1,08x1,34	2,75x1,08x1,34	3,25x1,08x1,34	2,84x1,15x1,34	3,34x1,15x1,46
Weight	kg	1.720	1.970	2.100	2.370	2.720
Part No.		320555	320558	320557	320559	320560

Conventional Horizontal Lathes

V-Turn 410 PRO



V-constant - during facing the spindle speed automatically adjusts according to the changing workpiece diameter

Top model of the V-Turn series with infinitely variable spindle speed and constant cutting speed, as well as rapid traverse and modern ergonomic design

- Ergonomic machine housing
- Improved apron with automated feed
- Constant cutting speed
- High spindle speed and motor power
- Roller bearings from world-leading manufacturer NSK

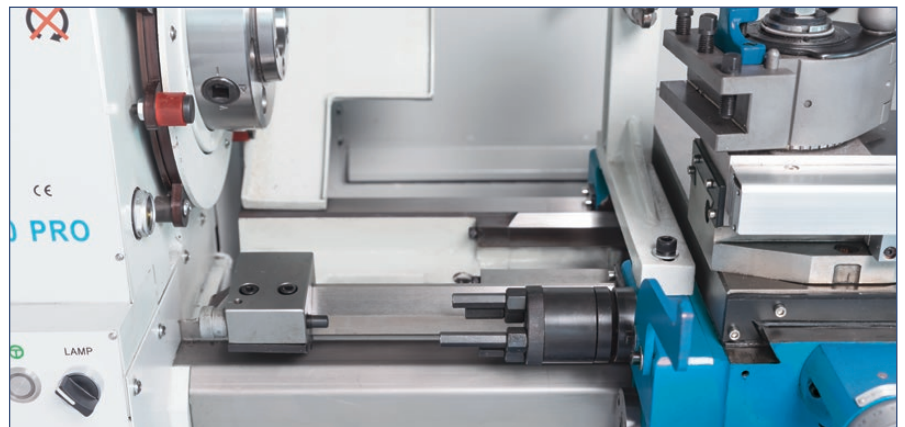

A micrometer bed stop featuring a turret for 4 stop positions ensures maximum repeatability



INFO



VIDEO



Central lubrication is integrated into the support for easy maintenance and handling

STANDARD EQUIPMENT

- ✓ 3-axis position indicator, X.pos 3.2 VC
- ✓ 4-jaw face plate chuck Ø 250 mm
- ✓ Face plate, Ø 350 mm
- ✓ Quick change tool holder head WB
- ✓ Quick change tool holder WBD 25120
- ✓ Coolant system
- ✓ Steady rest
- ✓ Chip tray
- ✓ Fixed splash guard (wall)
- ✓ Traveling cover for the toolpost
- ✓ Follow rest
- ✓ Turret stop
- ✓ Micrometer stop
- ✓ Foot brake pedal
- ✓ Chuck guard
- ✓ Work light
- ✓ Dead center
- ✓ Reducing Sleeve
- ✓ Fixed stainless steel safety cover for tension and lead screw
- ✓ Toolbox with operating tools
- ✓ Operator instructions

SPECIFICATIONS

Machine model numbers		V-Turn 410 PRO
Working area		
Center width	mm	1.000
Center height	mm	205
Turning diameter over bed	mm	380
Turning diameter over gap bridge	mm	580
Turning-Ø over support	mm	255
Gap bridge length	mm	250
Bed width	mm	250
Travels		
Travel X-axis	mm	210
Travel Z1-axis	mm	140
Swing range of top slide		± 45°
Headstock		
Speed range, high	1/min	550 - 3.000
Speed range, low	1/min	30 - 550
Spindle bore	mm	52
Spindle mount		Camlock D1-6
Spindle taper	MT	6
Feed		
Feed X-axis	mm/U	0,013 - 0,45
Feed Z-axis	mm/U	0,026 - 0,9
Threading		
Threading, metric	mm	(39) 0,2-14
Threading, diametric	DP	(21) 8-44
Threading, module	mm	(18) 0,3 - 3,5
Threading, whitworth	TPI	(45) 2-72
Tailstock		
Tailstock quill diameter	mm	50
Tailstock taper	MK	4
Tailstock quill stroke	mm	120
Tailstock traverse adjustment	mm	± 13
Drive capacity		
Motor rating main drive	kW	5,5
Measures and weights		
Overall dimensions (L x w x h)	m	1,94x1x1,6
Weight	kg	1.210
Part No.		300822

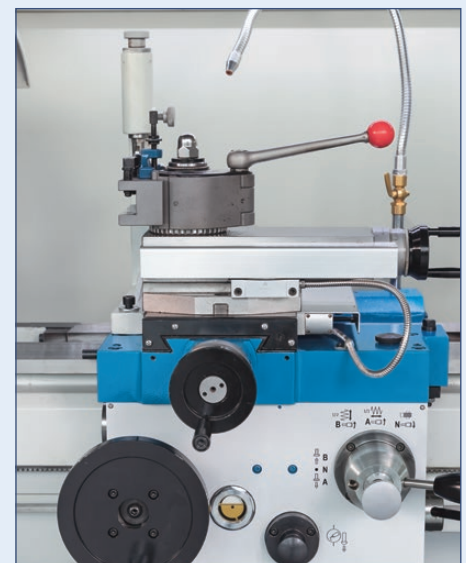

Extensive accessories, including quick-change tool holder system

Conventional Horizontal Lathes

V-Turn Series

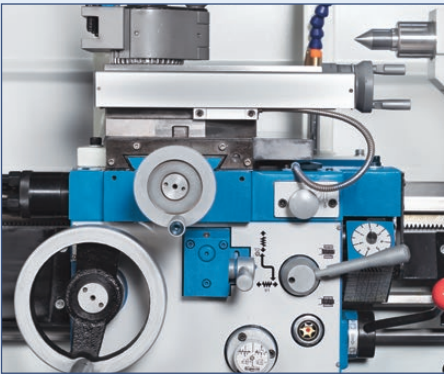

Model is equipped with integrated central lubrication at the support for low maintenance



INFO



VIDEO

Best selling machine class featuring constant cutting speed and extensive package of accessories

- Constant cutting speed
- High spindle speed and motor power
- Extensive standard equipment
- Roller bearing from world-leading manufacturer NSK

STANDARD EQUIPMENT

- | | |
|---|--------------------------------------|
| ✓ 3-axis position indicator, X.pos 3.2 VC | ✓ Micrometer stop |
| ✓ Follow rest | ✓ Chip tray |
| ✓ Dead center | ✓ Fixed splash guard (wall) |
| ✓ Reducing Sleeve | ✓ Protective shield for the toolpost |
| ✓ 4-jaw face plate chuck Ø 250 mm | ✓ Chuck guard |
| ✓ Face plate | ✓ Foot brake pedal |
| ✓ Quick change tool holder head WB | ✓ Work light |
| ✓ Quick change tool holder | ✓ Thread gauge |
| ✓ Coolant system | ✓ Toolbox with operating tools |
| ✓ Steady rest | ✓ Operator instructions |
| ✓ Turret stop | |

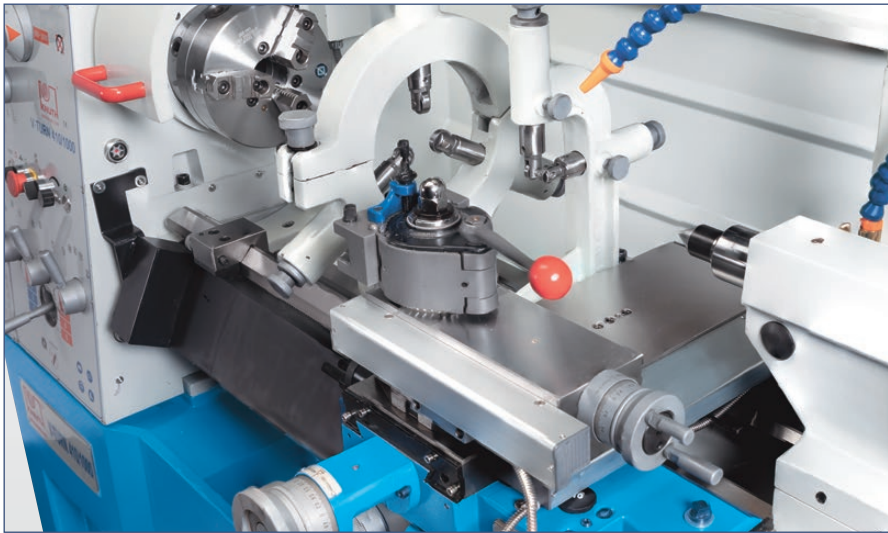

High-quality quick-change tool holder with 0.01 mm repeatability



Headstock gears and shafts are hardened and ground for quiet operation and constant speed

SPECIFICATIONS

Machine model numbers		410/1000	410/1500
Working area			
Center width	mm	1.000	1.500
Center height	mm	205	205
Turning diameter over bed	mm	380	380
Turning diameter over gap bridge	mm	580	580
Turning-Ø over support	mm	255	255
Gap bridge length	mm	250	250
Bed width	mm	250	250
Travels			
Travel X-axis	mm	210	210
Travel Z1-axis	mm	140	140
Swing range of top slide		± 45°	± 45°
Headstock			
Speed range, high	1/min	550 - 3.000	550 - 3.000
Speed range, low	1/min	30 - 550	30 - 550
Spindle bore	mm	52	52
Spindle mount		Camlock D1-6	Camlock D1-6
Spindle taper	MT	6	6
Feed			
Feed X-axis	mm/U	0,025 - 0,85	0,025 - 0,85
Feed Z-axis	mm/U	0,05 - 1,7	0,05 - 1,7
Threading			
Threading, metric	mm	(39) 0,2-14	(39) 0,2-14
Threading, diametric	DP	(21) 8-44	(21) 8-44
Threading, module	mm	(18) 0,3 - 3,5	(18) 0,3 - 3,5
Threading, whitworth	TPI	(45) 2-72	(45) 2-72
Tailstock			
Tailstock quill diameter	mm	50	50
Tailstock taper	MT	4	4
Tailstock quill stroke	mm	120	120
Tailstock traverse adjustment	mm	± 13	± 13
Drive capacity			
Motor rating main drive	kW	5,5	5,5
Measures and weights			
Overall dimensions (L x w x h)	m	1,94x1x1,32	2,44x1x1,32
Weight	kg	1.200	1.800
Part No.		300820	300821

Mechanics Lathes

Basic 180 V



With extra wide bed, infinitely variable spindle speed and constant cutting speed

- Largest bed width in this machine class
- Constant cutting speed
- High spindle speed and motor power
- Extensive standard equipment for a wide range of applications

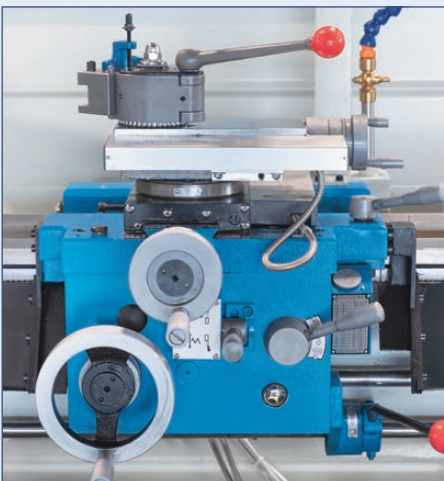

Perfect for plain turning, facing, thread cutting, and taper turning



INFO

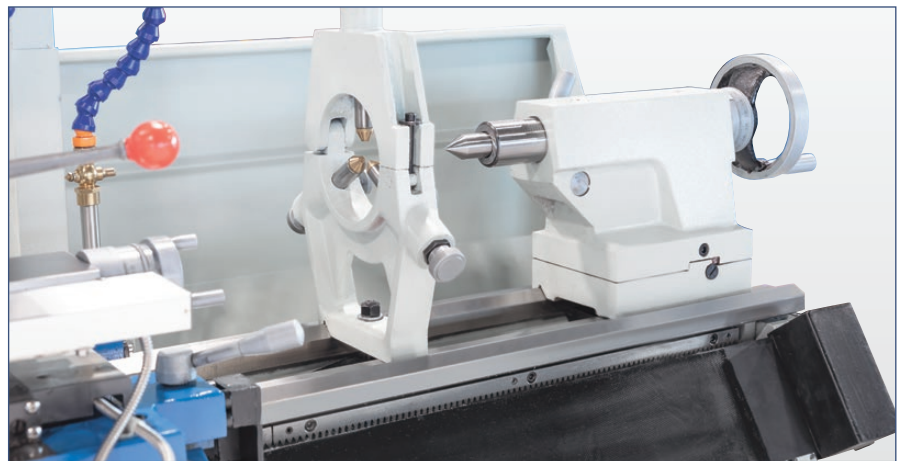

Rigid rests significantly increase turning precision and efficiency



Extensive Standard Equipment: Position indicator, rests, quick-action tool holders, and much more

STANDARD EQUIPMENT

- ✓ 3-axis position indicator, X.pos 3.2 VC
- ✓ 4-jaw face plate chuck Ø 200 mm
- ✓ Face plate Ø 320 mm
- ✓ Quick change tool holder head WE
- ✓ Quick change tool holder WED 20100
- ✓ Coolant system
- ✓ Steady and follow rests
- ✓ Chip tray
- ✓ Fixed splash guard (wall)
- ✓ Chuck guard
- ✓ Foot brake pedal
- ✓ Work light
- ✓ Micrometer stop
- ✓ Reducing sleeve
- ✓ Dead center
- ✓ Protective shield for the toolpost
- ✓ Thread gauge
- ✓ Toolbox with operating tools
- ✓ Operator instructions

SPECIFICATIONS

Machine model numbers		Basic 180 V
Working area		
Center width	mm	1.000
Turning diameter over bed	mm	356
Turning-Ø over support	mm	220
Bed width	mm	206
Travels		
Travel X-axis	mm	178
Travel Z1-axis	mm	92
Swing range of top slide		± 50°
Headstock		
Spindle speed	1/min	30 - 3.000
Spindle mount		Camlock D1-4
Spindle bore	mm	38
Spindle taper	MT	5
Feed		
Feed X-axis	mm/U	0,014 - 0,206
Feed Z-axis	mm/U	0,043 - 0,653
Threading		
Threading, metric	mm	(37) 0,4-7
Threading, whitworth	TPI	(28) 4-56
Tailstock		
Tailstock quill diameter	mm	45
Tailstock taper	MT	3
Tailstock quill stroke	mm	120
Tailstock traverse adjustment	mm	± 10
Drive capacity		
Motor rating main drive	kW	4
Measures and weights		
Overall dimensions (l x w x h)	m	1,95x0,75x1,55
Weight	kg	880
Part No.		300807

OPTIONAL EQUIPMENT

- Oscillation Element LK 3 103330



Change gears provide for a wide range of thread leads and feeds

Mechanics Lathes

Basic 180 Super



Support with enclosed oil-bath for low maintenance

Heavy mechanic's lathe with extensive accessories, extra wide bed and high cutting performance

- Heavy-duty wide machine bed
- Rugged construction for minimal vibration
- Powerful motor for demanding operations
- Extensive standard equipment for a wide range of applications

STANDARD EQUIPMENT

- | | |
|---------------------------------------|--------------------------------------|
| ✓ 3-axis position indicator X.Pos 3.2 | ✓ Reducing sleeve |
| ✓ Quick change tool holder head WE | ✓ Dead center |
| ✓ Quick change tool holder WED 20100 | ✓ Protective shield for the toolpost |
| ✓ 3-jaw chuck Ø 160 mm | ✓ Chuck guard |
| ✓ 4-jaw face plate chuck Ø 200 mm | ✓ Foot brake pedal |
| ✓ Face plate Ø 320 mm | ✓ Fixed splash guard (wall) |
| ✓ Steady and follow rests | ✓ Work light |
| ✓ Coolant system | ✓ Chip tray |
| ✓ Micrometer stop | ✓ Operator instructions |
| ✓ Thread gauge | ✓ Toolbox with operating tools |





Large bed width of 206 mm and 30% higher total weight have a positive impact on machining power and precision



Headstock gears and shafts are hardened and ground for quiet operation and constant speed

SPECIFICATIONS

Machine model numbers		Basic 180 Super
Working area		
Center width	mm	1.000
Turning diameter over bed	mm	356
Turning-Ø over support	mm	220
Bed width	mm	206
Travels		
Travel X-axis	mm	178
Travel Z1-axis	mm	92
Swing range of top slide		± 50°
Headstock		
Spindle speed	1/min	(16) 45 - 1.800
Spindle bore	mm	38
Spindle mount		Camlock D1-4
Spindle taper	MT	5
Feed		
Feed X-axis	mm/U	0,015 - 0,22
Feed Z-axis	mm/U	0,043 - 0,653
Threading		
Threading, metric	mm	(37) 0,4-7
Threading, whitworth	TPI	(28) 4-56
Tailstock		
Tailstock quill diameter	mm	45
Tailstock taper	MT	3
Tailstock quill stroke	mm	120
Tailstock traverse adjustment	mm	± 10
Drive capacity		
Motor rating main drive	kW	2,4
Measures and weights		
Overall dimensions (L x w x h)	m	1,95x0,75x1,55
Weight	kg	880
Part No.		300805

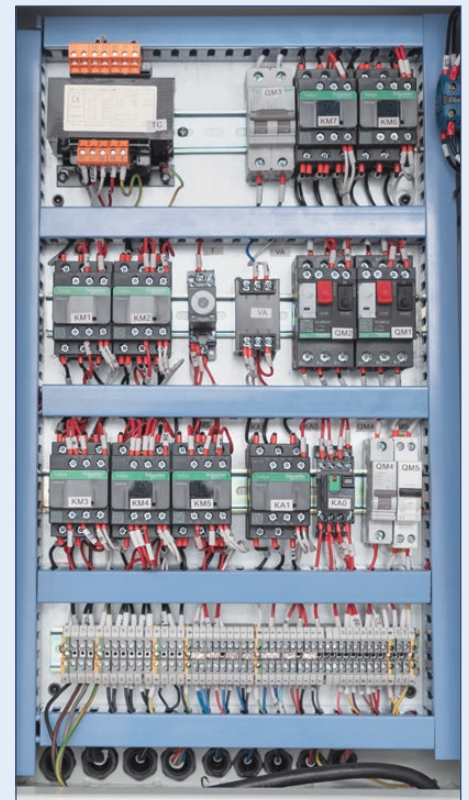

High-quality electric components by Siemens ensure maximum reliability

Basic 170 Super PRO

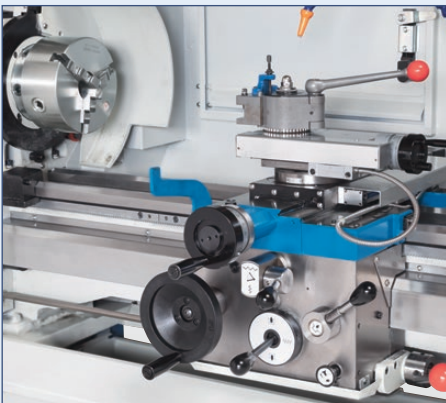

Stainless steel covers on lead screw and feed shaft ensure safety and reliable protection against contamination and premature wear

Top model of the mechanic's lathes, perfect for workshop and training with complete equipment and modern ergonomics

- Modern ergonomic design
- Large spindle bore
- Machine base with storage space
- Extensive standard equipment
- Coolant system

STANDARD EQUIPMENT

- ✓ 3-axis position indicator X.Pos 3.2
- ✓ Quick change tool holder head WE
- ✓ Quick change tool holder WED 20100
- ✓ 3-jaw-chuck 178 mm
- ✓ 4-jaw face plate chuck Ø 200 mm
- ✓ Face plate Ø 280 mm
- ✓ Steady and follow rests
- ✓ Coolant system
- ✓ Micrometer stop
- ✓ Reducing sleeve
- ✓ Dead center
- ✓ Traveling cover for the toolpost
- ✓ Fixed stainless steel safety cover for tension and lead screw
- ✓ Chuck guard
- ✓ Foot brake pedal
- ✓ Fixed splash guard (wall)
- ✓ Work light
- ✓ Chip tray
- ✓ Toolbox with operating tools
- ✓ Operator instructions



INFO



VIDEO



The machine base features ample storage space for accessories and tools, including a chip tray that can be removed at front



The operator elements are very clearly organized

SPECIFICATIONS

Machine model numbers Basic 170 Super PRO

Working area

Center width	mm	1.000
Center height	mm	179
Turning diameter over bed	mm	354
Turning- \varnothing over support	mm	223
Bed width	mm	187

Travels

Travel X-axis	mm	185
Travel Z1-axis	mm	95

Headstock

Spindle speed	1/min	(8) 70 - 2.000
Spindle bore	mm	52
Spindle mount		Camlock D1-5
Spindle taper	MT	6

Feed

Feed X-axis	mm/U	(24) 0,0291 - 2,035
Feed Z-axis	mm/U	(24) 0,0406 - 2,842

Threading

Threading, metric	mm	(48) 0,2 - 14
Threading, whithworth	TPI	(56) 2 - 56
Threading, diametric	DP	(32) 8 - 56
Threading, module	MP	(34) 0,2 - 3,5

Tailstock

Tailstock quill diameter	mm	42
Tailstock taper	MT	3
Tailstock quill stroke	mm	100

Drive capacity

Motor rating main drive	kW	1,5
-------------------------	----	-----

Measures and weights

Overall dimensions (L x w x h)	m	1,9x0,76x1,6
Weight	kg	650
Part No.		300814

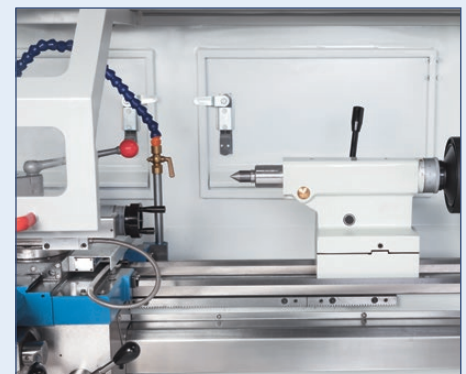

Tailstock can be moved sideways for taper turning



The work area is also accessible from the rear of the machine via large flaps

Mechanics Lathes

Basic 170 Super

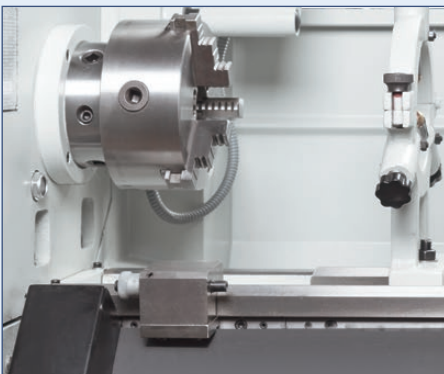

Micrometer bed stop ensures repeatability

Solid precision bench lathe with large center width

- Compact design for small footprint
- Extensive standard equipment for a wide range of applications
- 3-axis position indicator with turning functions

STANDARD EQUIPMENT

- | | |
|---------------------------------------|--------------------------------------|
| ✓ 3-axis position indicator X.Pos 3.2 | ✓ Dead center |
| ✓ Quick change tool holder head WE | ✓ Protective shield for the toolpost |
| ✓ Quick change tool holder WED 20100 | ✓ Chuck guard |
| ✓ 3-jaw chuck Ø 160 mm | ✓ Foot brake pedal |
| ✓ 4-jaw face plate chuck Ø 200 mm | ✓ Fixed splash guard (wall) |
| ✓ Face plate Ø 280 mm | ✓ Work light |
| ✓ Steady and follow rests | ✓ Chip tray |
| ✓ Micrometer stop | ✓ Toolbox with operating tools |
| ✓ Thread gauge | ✓ Operator instructions |
| ✓ Reducing sleeve | |



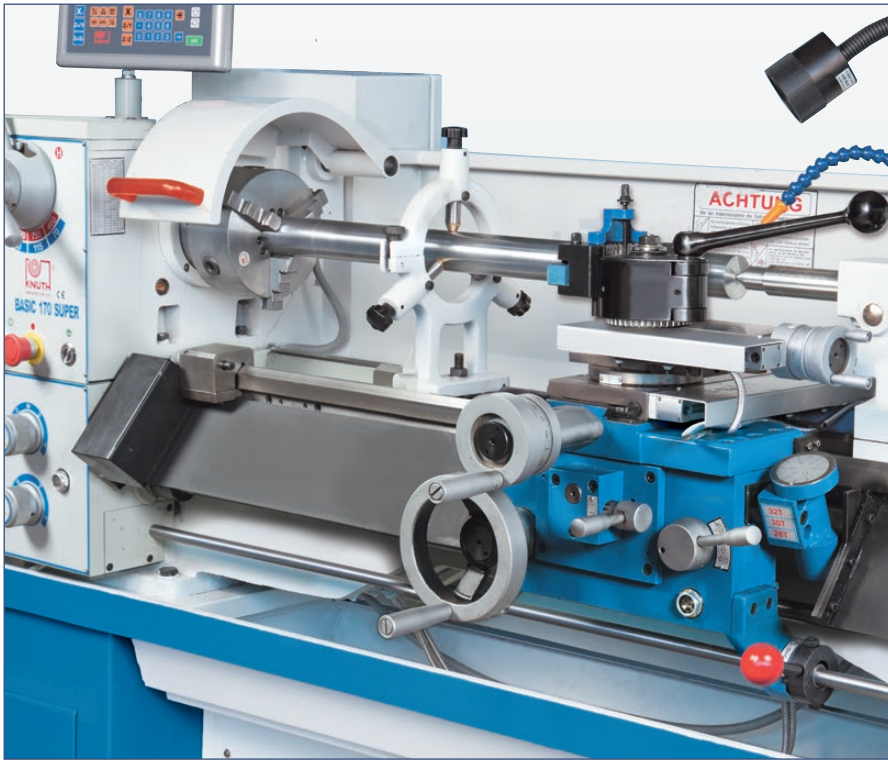

Long workpieces are supported in rigid rests

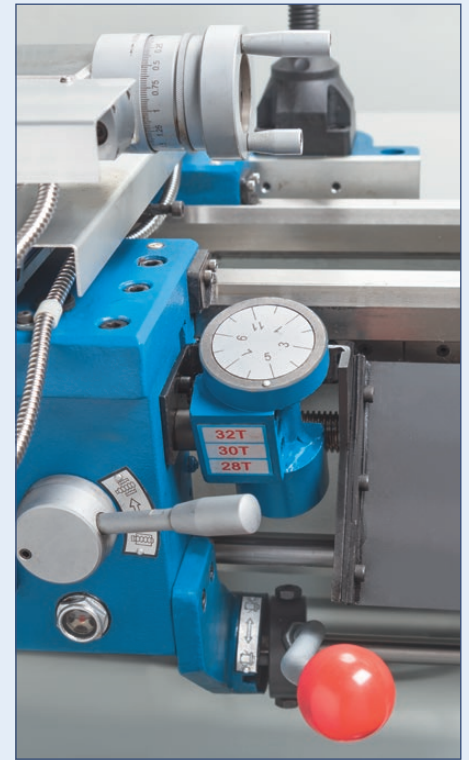

The thread gauge allows for resuming the thread after the apron nut for retrograde motion has been opened

SPECIFICATIONS

Machine model numbers		Basic 170 Super
Working area		
Center width	mm	1.000
Turning diameter over bed	mm	330
Turning-Ø over support	mm	198
Travels		
Travel X-axis	mm	170
Travel Z1-axis	mm	95
Swing range of top slide		± 360°
Headstock		
Spindle speed	1/min	(8) 70 - 2.000
Spindle bore	mm	38
Spindle mount		Camlock D1-4
Spindle taper	MT	5
Feed		
Feed X-axis	mm/U	0,014 - 0,38
Feed Z-axis	mm/U	0,052 - 1,392
Threading		
Threading, metric	mm	(26) 0,4-7
Threading, whitworth	TPI	(34) 4-56
Tailstock		
Tailstock quill diameter	mm	33
Tailstock taper	MT	3
Tailstock quill stroke	mm	100
Tailstock traverse adjustment	mm	± 10
Drive capacity		
Motor rating main drive	kW	1,5
Measures and weights		
Overall dimensions (L x w x h)	m	1,83x0,68x1,32
Weight	kg	520
Part No.		300815

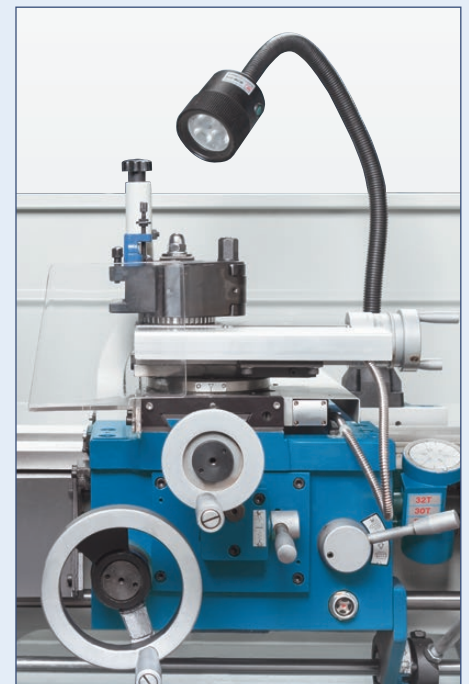

Multi-functional quick-action tool holder simplifies tool changes and tool setup

Mechanics Lathes

Basic Plus

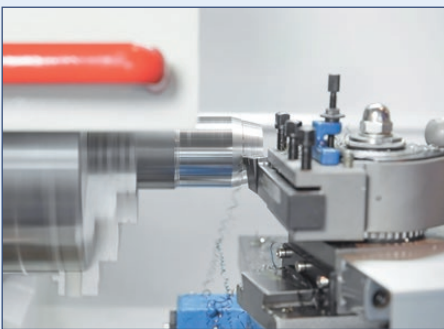

Quick-action tool holder for fast tool setup and easy tool changing with 0.01 mm repeatability

Best-selling entry-level lathe with extended list of standard accessories, also ideal for training

- Robustness and precision
- Compact design with small footprint
- Extensive standard equipment
- Quick change tool holder
- Assembled 3-axis position indicator

STANDARD EQUIPMENT

- | | |
|---------------------------------------|--------------------------------------|
| ✓ 3-axis position indicator X.Pos 3.2 | ✓ Reducing sleeve |
| ✓ Quick change tool holder head WA | ✓ Dead center |
| ✓ Quick change tool holder WAD 1675 | ✓ Protective shield for the toolpost |
| ✓ 3-jaw chuck Ø 160 mm | ✓ Chuck guard |
| ✓ 4-jaw face plate chuck Ø 200 mm | ✓ Fixed splash guard (wall) |
| ✓ Face plate Ø 250 mm | ✓ Work light |
| ✓ Steady and follow rests | ✓ Toolbox with operating tools |
| ✓ Micrometer stop | ✓ Operator instructions |
| ✓ Thread gauge | |





Steady and follow rests are included



Positioning indicator on X, Z and Z1 axis

SPECIFICATIONS		
Machine model numbers		Basic Plus
Working area		
Center width	mm	810
Turning diameter over bed	mm	300
Turning-Ø over support	mm	178
Bed width	mm	180
Travels		
Travel X-axis	mm	155
Travel Z1-axis	mm	95
Swing range of top slide		± 60°
Headstock		
Spindle speed (9x2)	1/min	60 - 1.550
Spindle bore	mm	38
Spindle mount		Camlock D1-4
Spindle taper	MT	5
Feed		
Feed X-axis	mm/U	0,014 - 0,38
Feed Z-axis	mm/U	0,052 - 1,392
Threading		
Threading, metric	mm	(26) 0,4-7
Threading, whitworth	TPI	(34) 4-56
Tailstock		
Tailstock quill diameter	mm	32
Tailstock taper	MT	3
Tailstock quill stroke	mm	100
Tailstock traverse adjustment	mm	± 10
Drive capacity		
Motor rating main drive	kW	1,1
Measures and weights		
Overall dimensions (L x w x h)	m	1,6x0,75x1,27
Part No.	kg	520
Part No.		300809



Quick-change tool holder system makes turning tools instantly available for use

Milling Accessories



Tool Holders



The tool holder segment includes various items for milling, drilling, turning and other machining processes. In most cases they allow the forces to be transferred between the tool and the machine. In addition to milling arbors and adapters, there are also drill chucks, drilling tools and tool holders in a wide variety of sizes.

Workpiece Holding



Precise positioning and fixing of the workpiece is crucial for precise machining. Depending on the processing and type of processing required, various fixing elements are available. In addition to the classic vices and clamping tables, dividing devices for precise angular alignment are also available. The range is expanded by clamping tools such as collets and chucks for precisely fitting fixation.

Machining Tools



The tool segment includes wear and tear parts as well as spare parts for machining types such as milling, turning and drilling. In addition to broaches for making grooves and other notches, there are various end mills for roughing and finishing. Furthermore, reamer and countersinking tools are included in this category with which, for example, bores can be reworked. Various tools are also available for turning and drilling. When selecting the suitable tool, attention must be paid not only to the tool dimensions but also to compatibility with the respective tool holder.

Measuring technology



The required tolerances and dimensions can only be adhered to by constantly monitoring the decisive parameters. For this purpose, KNUTH machine tools provides various measuring equipment and control elements. In addition to dial gauges and analog or digital micrometers, measuring and control plates can also be used.

The new KNUTH Accessory Shop is now live! → Shop now



Milling Machines

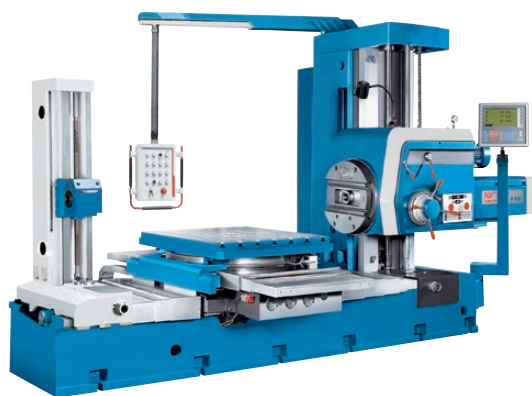

Boring Machines

from Page 32



Servo-conventional Page 36/37, 44/45



Universal Milling Machines from Page 38



Multipurpose Milling Machines Page 48/49



Drill Press/Milling Machines from Page 56

Conventional Milling and Boring Machines

BO 110

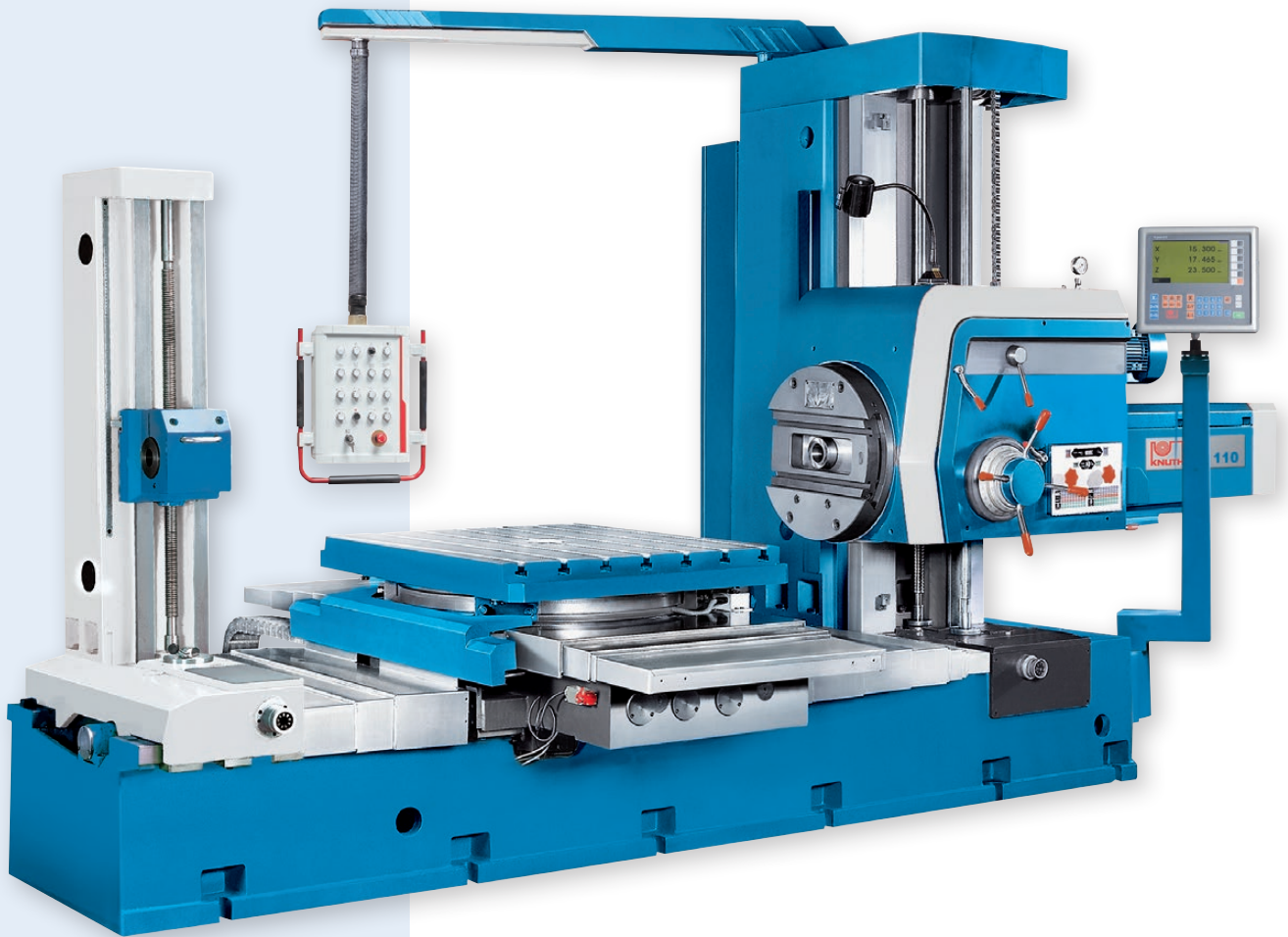

For heavy and demanding machining of up to 2.5 T workpiece weight

- Large work area with W-axis and facing slide
- Thread cutting unit
- Rotatable clamping table with sighting device for 4 positions
- Telescoping stainless steel covers on all guides

STANDARD EQUIPMENT

- ✓ 3-axis position indicator X.Pos 3.2
- ✓ Wedge strip
- ✓ Central lubrication
- ✓ Work lamp
- ✓ Foundation bolts
- ✓ Operating tools
- ✓ Operator instructions

OPTIONAL EQUIPMENT

- Drilling tool holder for faceplate 252278
- Milling cutter holder for faceplate 252279
- Boring head 252280
- Position indicator at the rotary table 252720



INFO

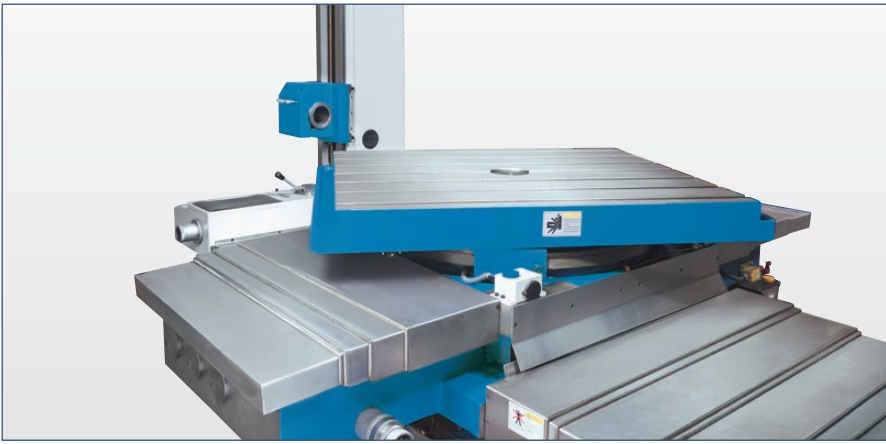

Rotating setup table with sighting mechanism for 4 positions



Facing slide with long stroke for internal turning

SPECIFICATIONS		
Machine model numbers	BO 110	
Working area		
Drilling capacity	mm	50
Table set up area	mm	1.100x960
Table load capacity	kg	2.500
Table rotation range		4 x 90°
Spindle axis-to-table surface distance	mm	0 - 900
Rotation speed of rotary table	1/min	1
Travels		
Travel X-axis	mm	900
Travel Y-axis	mm	900
Travel Z-axis	mm	900
Travel W-axis	mm	600
Facing slide travel	mm	180
Headstock		
Speed range	1/min	(22) 8 - 1.000
Spindle diameter	mm	110
Spindle torque (max.)	Nm	1.225
Spindle mount		SK 50 DIN 2080
Facing slide speed	1/min	(18) 4 - 200
Feed force, axial (max.)	kN	12,25
Facing slide torque (max.)	Nm	1.960
Rapid feed		
Rapid feed X-axis	mm/min	2.500
Rapid feed Y-axis	mm/min	2.500
Rapid feed W-axis	mm/min	2.500
Feed		
Feed X-axis	mm/U	(36) 0,01 - 6
Feed Y-axis	mm/U	(36) 0,01 - 6
Feed Z-axis	mm/U	(36) 0,01 - 6
Feed W-axis	mm/U	(36) 0,01 - 6
Facing slide feed	mm/min	(18) 0,08 - 12
Accuracies		
Read-out accuracy (optic)	mm	0,01
Counter-bore accuracy	µm	H7 Ra-1,6
Drive capacity		
Motor rating main drive	kW	7,5
Motor rating, rapid reed	kW	3
Motor rating hydraulic pump	kW	0,37
Measures and weights		
Overall dimensions (L x w x h)	m	4,88x2,45x2,75
Weight	kg	11.500
Part No.		301499



Headstock and feed gears are equipped with an overload clutch

Conventional Milling and Boring Machines

BO 130

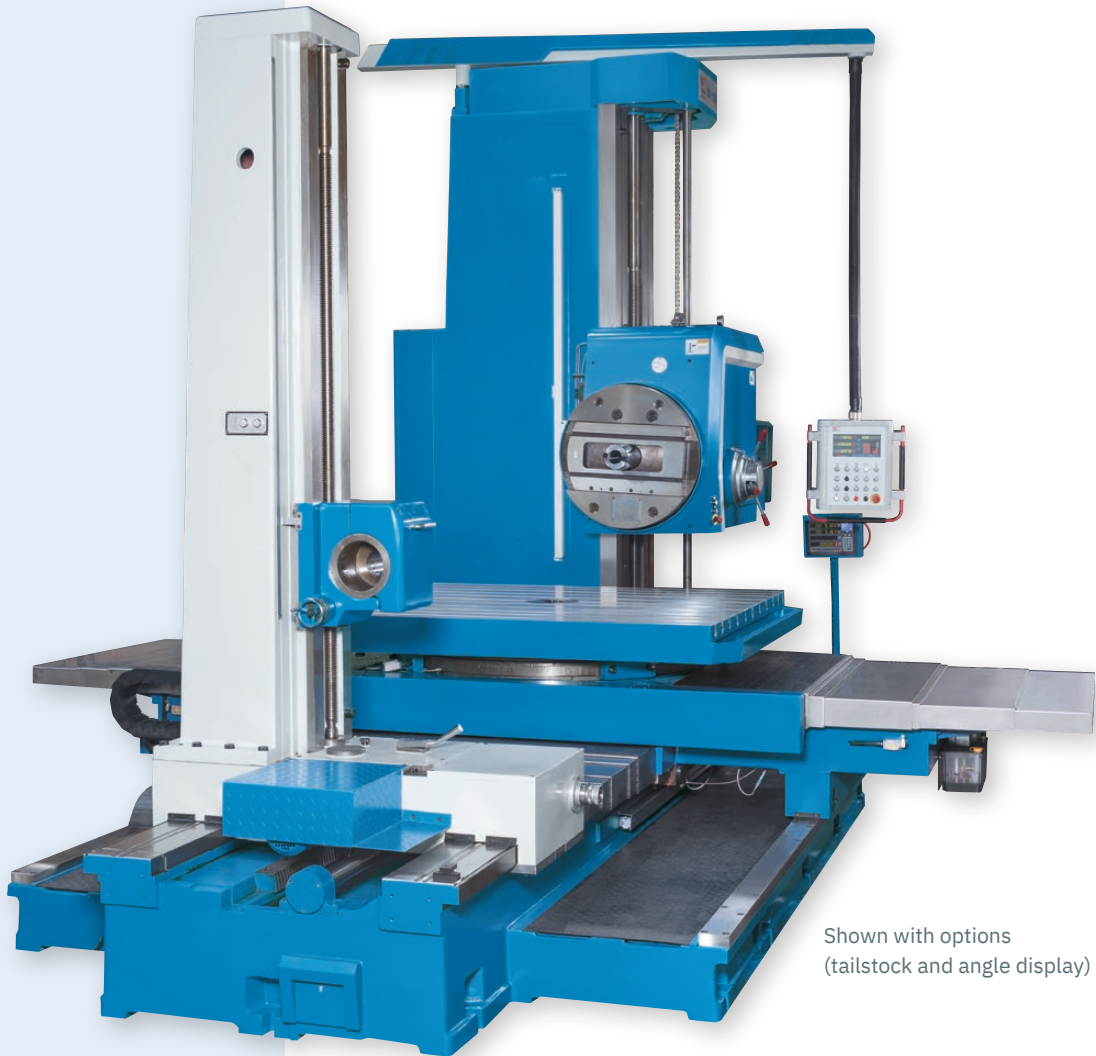

Shown with options
(tailstock and angle display)

For heavy and demanding machining of up to 10 T workpiece weight

- Large work area with W-axis and facing slide
- Thread cutting unit
- Rotatable clamping table with sighting device for 4 positions
- Telescoping stainless steel covers on all guides

STANDARD EQUIPMENT

- ✓ 3-axis position indicator X.Pos 3.2
- ✓ Wedge strip
- ✓ Central lubrication
- ✓ Work lamp
- ✓ Foundation bolts
- ✓ Operating tools
- ✓ Operator instructions

OPTIONAL EQUIPMENT

- Boring tool holder for facing plate for BO 130 250606
- Milling tool holder for facing plate for BO 130 250607
- Boring head 250609
- Rotary table position indicator (angle display) 252721
- Tailstock 254161



INFO

Servomill® UWF Series

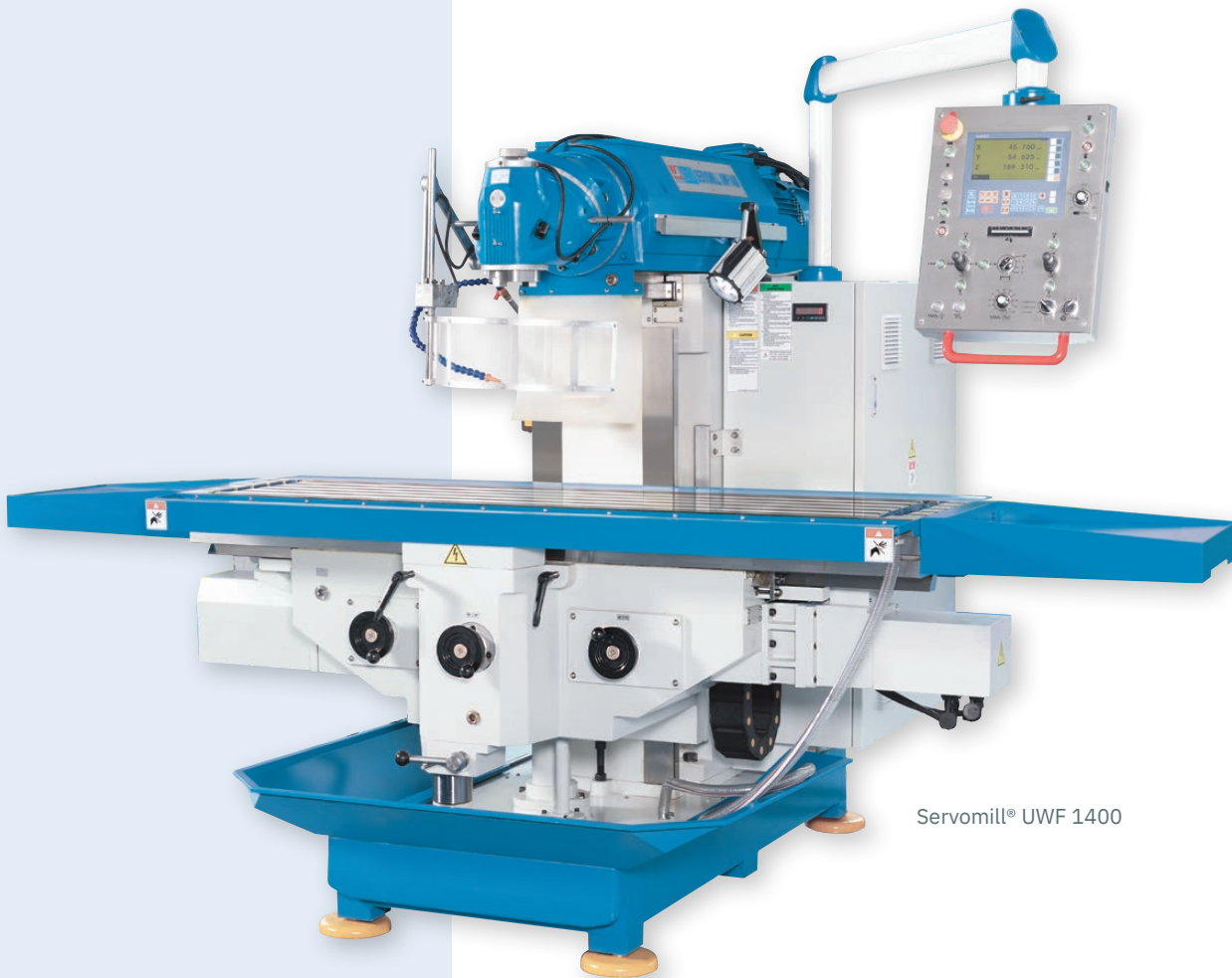

Servomill® UWF 1400



The complete drive is integrated in the heavy top beam that positions the cutter head

Servo-conventional milling machine with large work area and universal cutter head

- Large work area
- Servo-conventional feed technology
- Preloaded ball screws on all axes
- Electronic hand-wheels
- Universal cutter head with 2 swivel axes
- Infinitely variable spindle speed

STANDARD EQUIPMENT

- | | |
|---|---|
| ✓ Control panel with X.Pos 3.2 and extended functions | ✓ Heat exchanger for electrical control cabinet |
| ✓ Ball screw drives and servo direct drives in all axes | ✓ Protection shield |
| ✓ Automatic feed with electric limit switches in all axes | ✓ Coolant system |
| ✓ Electronic handwheels | ✓ LED work light |
| ✓ Accessories for milling | ✓ Operating tool |
| ✓ Automatic central lubrication | ✓ Operator instructions |





The precise and regular lubrication of all relevant components results in a significant reduction of component wear. This leads to an extended machine and component life.



The infinitely variable spindle speed is easy to read on a digital display

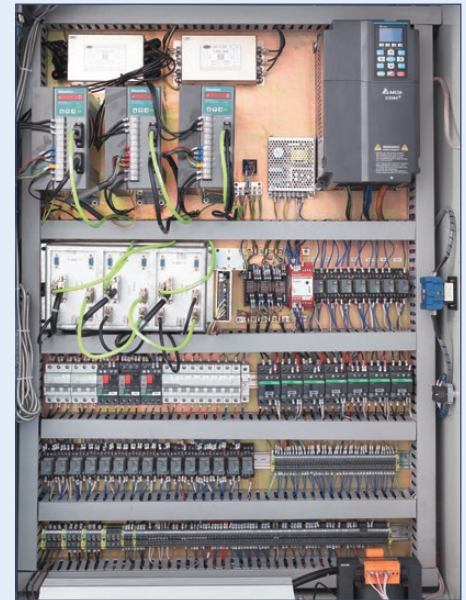

Premium electric components plus clean wiring minimize disruptions

SPECIFICATIONS

Machine model numbers		UWF 900	UWF 1200	UWF 1400
Working area				
Table dimensions	mm	1.235x460	1.600x500	2.000x500
Table load capacity	kg	800	1.800	1.800
Number of T-slots	positions	5	5	5
T-slots, width	mm	18	18	18
T-slots, spacing	mm	80	80	80
Travels				
Travel X-axis	mm	900	1.200	1.400
Travel Y-axis	mm	650	700	700
Verfahrweg Z-Achse	mm	450	500	500
Milling Head				
Speed range (2)	1/min	30-390 / 390-2050	30-390 / 390-2050	30-390 / 390-2050
Spindle mount		SK 40 DIN 2080	SK 50 DIN 2080	SK 50 DIN 2080
Swivel angle		360°	360°	360°
Spindle center-to-table distance	mm	30 - 480	50 - 550	50 - 550
Rapid feed				
Rapid feed X-axis	mm/min	2.200	2.200	2.200
Rapid feed Y-axis	mm/min	2.200	2.200	2.200
Rapid feed Z-axis	mm/min	1.100	1.100	1.100
Feed				
Feed speed X-axis	mm/min	10 - 1.000	10 - 1.000	10 - 1.000
Feed speed Y-axis	mm/min	10 - 1.000	10 - 1.000	10 - 1.000
Feed speed Z-axis	mm/min	5 - 640	5 - 500	5 - 500
Drive capacity				
Motor rating main drive	kW	7,5	11	11
Motor rating X axis feed	kW	3,6	3,6	3,6
Motor rating Y axis feed	kW	3,6	3,6	3,6
Motor rating Z axis feed	kW	5,5	5,5	5,5
Motor rating coolant pump	kW	0,13	0,13	0,13
Measures and weights				
Overall dimensions (L x w x h)	m	2x2,5x2	2,85x2,5x2,2	3,25x2,5x2,2
Weight	kg	4.000	4.200	4.500
Part No.		301290	301291	301292

Conventional Vertical Milling Machines

UWF 6

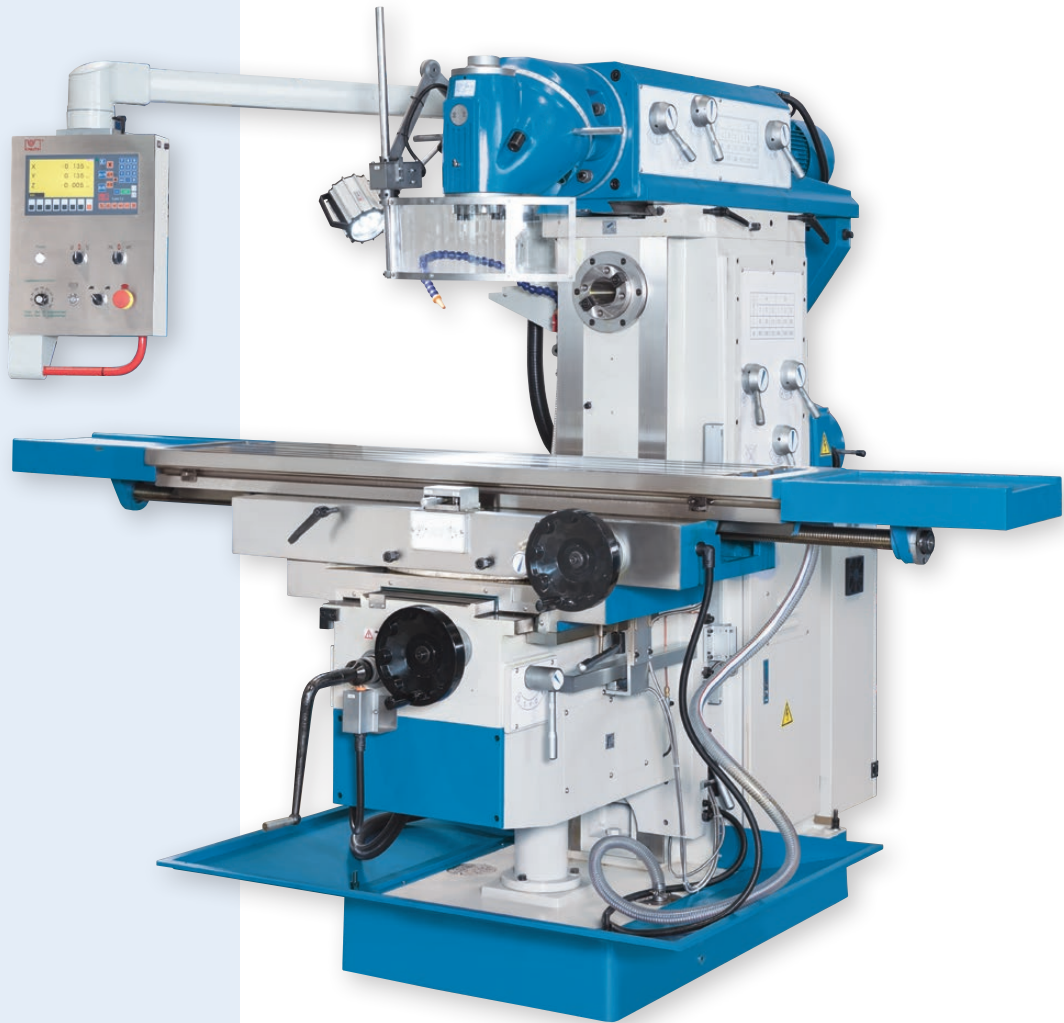

Manual central lubrication reduces maintenance and extends the machine life

With extended travel on axes, universal type milling head, ISO50 spindle, automatic feed on all axis and swiveling table

- Universal cutter head swivels on 2 levels
- Horizontal milling spindle with its own drive
- Swiveling milling table
- Servo-feed on all axes with rapid feed
- Extensive standard equipment

STANDARD EQUIPMENT

- | | |
|--|------------------------------|
| ✓ 3-axis position indicator X.Pos 3.2 | ✓ Coolant system |
| ✓ Reducing sleeve ISO 50 / MT4 | ✓ Work lamp |
| ✓ Milling arbor Ø 32 mm | ✓ Manual central lubrication |
| ✓ Horizontal arbor Ø 27 mm | ✓ Draw bar |
| ✓ Horizontal arbor Ø 32 mm | ✓ Operating tools |
| ✓ Outer arbor support for horizontal milling | ✓ Operator instructions |
| ✓ Chip tray | |





Large work area, cutter head swivels on 2 levels



Horizontal spindle with its own drive and finely stepped gearbox

SPECIFICATIONS

Machine model numbers		UWF 6
Working area		
Table dimensions	mm	1.600x360
Table load capacity (max.)	kg	500
Number of T-slots	positions	3
T-slot (width x spacing)	mm	18x80
Travels		
Travel X-axis	mm	1.300
Travel Y-axis	mm	300
Travel Z-axis	mm	400
Milling Head		
Speed range	1/min	(12) 60 - 1.750
Spindle mount		SK 50 DIN 2080
Swivel angle		360°
Upper beam travel	mm	550
Spindle center-to-table distance	mm	190 - 590
Rapid feed		
Rapid feed X-axis	mm/min	1.200
Rapid feed Y-axis	mm/min	800
Rapid feed Z-axis	mm/min	600
Horizontal Milling Spindle		
Spindle speed (horizontal)	1/min	(12) 60 - 1.800
Spindle mount		SK 50 DIN 2080
Horizontal spindle-to-table surface distance	mm	20 - 420
Spindle axis-to-top beam distance	mm	200
Feed		
Feed speed X-axis	mm/min	30 - 750
Feed speed Y-axis	mm/min	20 - 500
Feed speed Z-axis	mm/min	15 - 375
Drive capacity		
Motor rating horizontal spindle	kW	5,5
Motor rating vertical spindle	kW	4
Measures and weights		
Overall dimensions (l x w x h)	m	2,52x2,1x2
Weight	kg	2.950
Part No.		362751

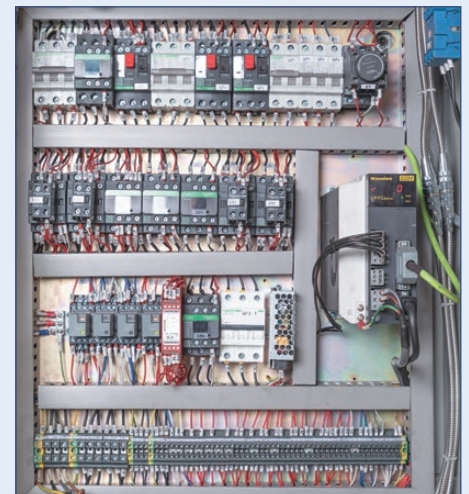

Premium electric components plus clean and structured wiring minimize disruptions



Swiveling control panel with integrated position indicator

Conventional Vertical Milling Machines

UWF 5

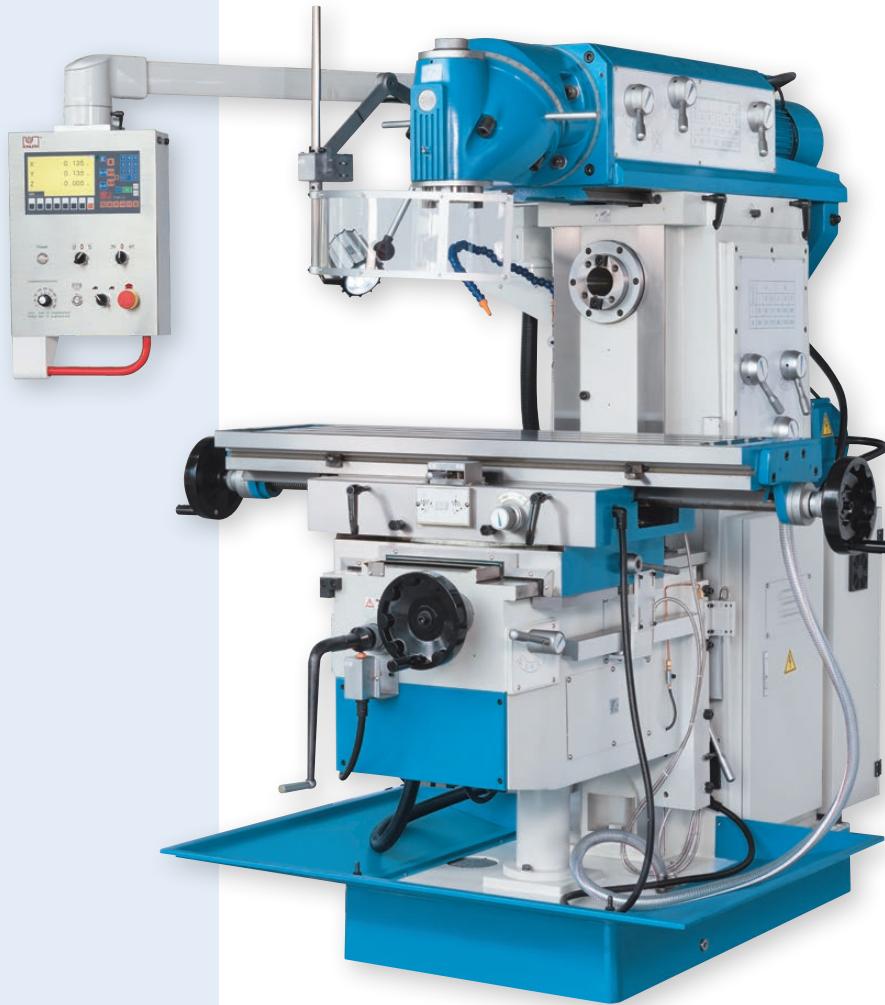

Universal milling head, swivelling in 2 positions



INFO

Heavy console milling machine with stable SK 50 spindle in the universal milling head, horizontal milling spindle, as well as swivel table and automatic feed in all axes.

- Universal cutter head swivels on 2 levels
- Horizontal milling spindle with its own drive
- Swiveling milling table
- Automatic feed in all axes with rapid feed
- Extensive standard equipment

STANDARD EQUIPMENT

- | | |
|--|-------------------------|
| ✓ 3-axis position indicator X.Pos 3.2 | ✓ Work lamp |
| ✓ Reducing sleeve ISO 50 / MT4 | ✓ Chip tray |
| ✓ Milling arbors (27, 32 mm) | ✓ Draw bar |
| ✓ Outer arbor support for horizontal milling | ✓ Operating tools |
| ✓ Collet chuck ISO 50 incl. collets
3-25mm (8 pieces) | ✓ Operator instructions |
| ✓ Coolant system | |



Large working area of 1325 x 360 mm and up to 500 kg table load

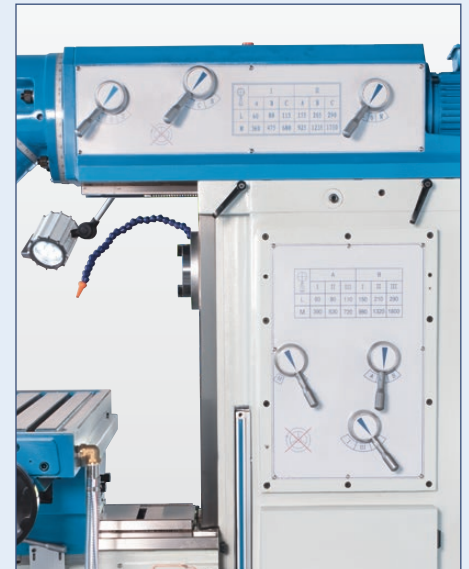

Universal milling machine with two separate drives for vertical and horizontal spindles

SPECIFICATIONS		
Machine model numbers		UWF 5
Working area		
Table dimensions	mm	1.325x360
Table load capacity (max.)	kg	500
Table swivel range r/l	deg	45
Number of T-slots	positions	3
T-slot (width x spacing)	mm	18x80
Travels		
Travel X-axis	mm	750
Travel Y-axis	mm	280
Travel Z-axis	mm	390
Milling Head		
Speed range	1/min	(12) 60 - 1.750
Spindle mount		SK 50 DIN 2080
Swivel angle		360°
Upper beam travel	mm	550
Spindle center-to-table distance	mm	175 - 565
Rapid feed		
Rapid feed X-axis	mm/min	1.200
Rapid feed Y-axis	mm/min	800
Rapid feed Z-axis	mm/min	600
Horizontal Milling Spindle		
Spindle speed (horizontal)	1/min	(12) 60 - 1.800
Spindle mount		SK 50 DIN 2080
Throat	mm	380 - 930
Feed		
Feed speed X-axis	mm/min	30 - 750
Feed speed Y-axis	mm/min	20 - 500
Feed speed Z-axis	mm/min	15 - 375
Drive capacity		
Motor rating horizontal spindle	kW	5,5
Motor rating vertical spindle	kW	4
Motor rating X axis feed	kW	1,5
Motor rating Y axis feed	kW	1,5
Motor rating Z axis feed	kW	1,5
Motor rating coolant pump	kW	0,09
Measures and weights		
Overall dimensions (L x w x h)	m	1,8x2,1x2
Weight	kg	2.850
Part No.		362750



Central lubrication facilitates machine maintenance.

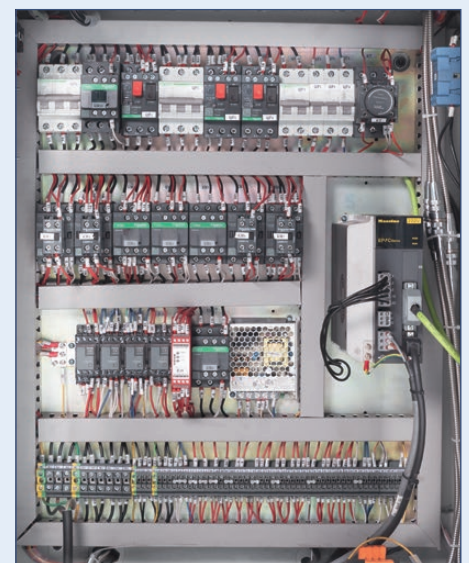

High-quality electrical components guarantee reliability

Conventional Vertical Milling Machines

UWF 3.2



Large rectangle guideways ensure maximum precision and quiet operation



INFO



VIDEO

With universal type milling head, automatic feed on all axis, swiveling table and horizontal spindle

- Universal cutter head swivels on 2 levels
- Outer arbor support for horizontal milling
- Swiveling milling table
- Servo-feed on all axes with rapid feed
- Extensive standard equipment

STANDARD EQUIPMENT

- ✓ 3-axis position indicator X.Pos 3.2
- ✓ Collet chuck with collets (4, 5, 6, 8, 10, 12, 14, 16 mm diam.)
- ✓ Horizontal arbor \varnothing 27 mm
- ✓ Outer arbor support for horizontal milling
- ✓ Chip tray
- ✓ Coolant system
- ✓ Central lubrication
- ✓ M16 draw bar
- ✓ LED work lamp
- ✓ Operating tools
- ✓ Operator instructions

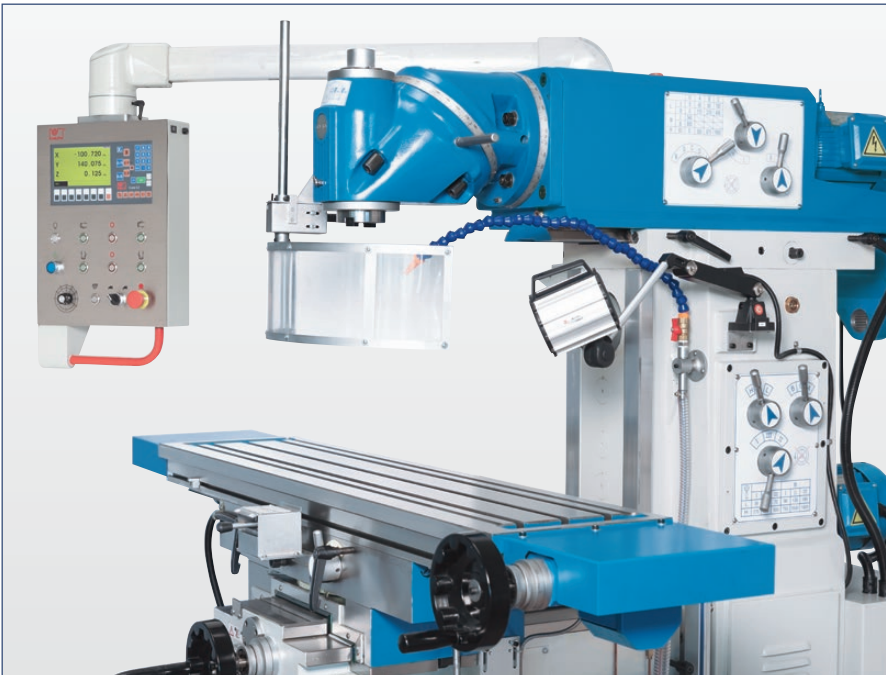

The universal cutter head features 2 swivel levels and can be moved to virtually any spatial angle



The milling table features a large setup area and can be rotated in linear direction

SPECIFICATIONS		
Machine model numbers		UWF 3.2
Working area		
Table set up area	mm	1.370x320
Table load capacity (max.)	kg	260
Table swivel range r/l	deg	45
Number of T-slots	positions	3
T-slot (width x spacing)	mm	14x80
Travels		
Travel X-axis	mm	1.000
Travel Y-axis	mm	360
Travel Z-axis	mm	400
Vertical milling head		
Spindle speed (vertical)	1/min	(11) 45 - 1.660
Spindle mount		SK 40 DIN 2080
Throat	mm	300 - 765
Vertical spindle-to-table surface distance	mm	260 - 660
Milling head swivel range	Grad	360
Rapid feed		
Rapid feed X-/ Y-axis	mm/min	1.335
Rapid feed Z-axis	mm/min	1.000
Horizontal Milling Spindle		
Spindle speed (horizontal)	1/min	(12) 35 - 1.500
Spindle mount		SK 40 DIN 2080
Horizontal spindle-to-table surface distance	mm	75 - 475
Feed		
Feed speed X-axis	mm/min	(9) 30 - 830
Feed speed Y-axis	mm/min	(9) 30 - 830
Feed speed Z-axis	mm/min	23 - 625
Drive capacity		
Motor rating horiz. / vert.	kW	3
Measures and weights		
Overall dimensions (l x w x h)	m	1,9x1,75x2
Weight	kg	1.950
Part No.		362695

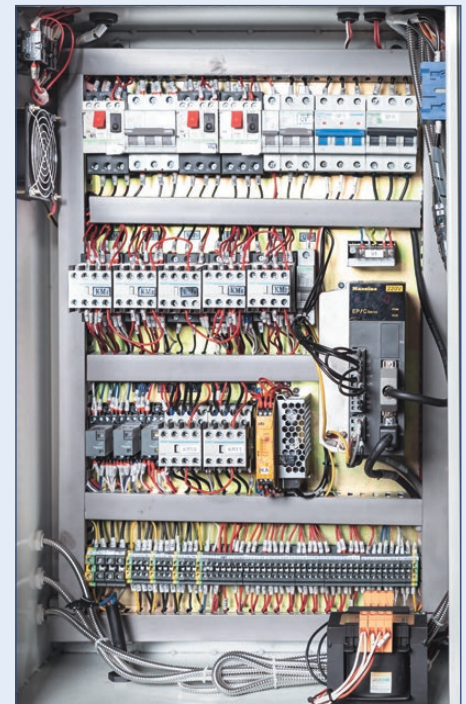

Premium components and clean wiring minimize the risk of failures and down-times

Servomill® FPK Series



Equipped with electronic hand-wheels and extended milling functions the Servomill offers the advantages of modern CNC technology in conventional machining



The next generation of servo-conventional toolroom milling machines

- Servo feed technology with electronic handwheels
- Ball screws in all axes
- 3-fold electronic stop
- Large vertical console and work table
- Vertical and horizontal spindle
- Infinitely variable spindle speed

STANDARD EQUIPMENT

- ✓ Control panel with X.Pos 3.2 and extended functions
- ✓ Ball screw drives and servo direct drives in all axes
- ✓ Automatic feed with electric limit switches in all axes
- ✓ Electronic handwheels
- ✓ Milling accessories
- ✓ Automatic central lubrication
- ✓ Heat exchanger for electrical control cabinet
- ✓ Protection shield
- ✓ Coolant system
- ✓ LED worklight
- ✓ Operator instructions

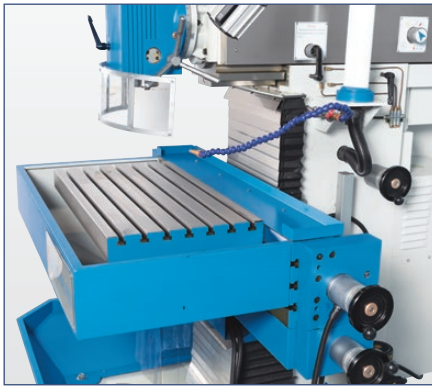

The large work table and long travels provide maximum versatility

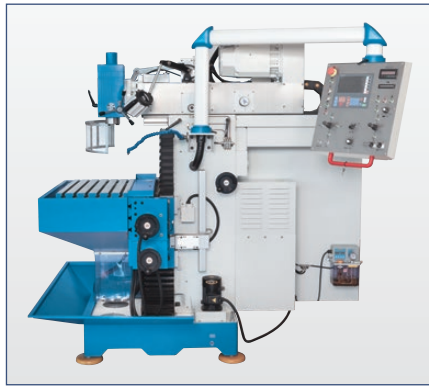

Practical layout of control elements allows streamlined and intuitive operation



Continuous precision lubrication minimizes friction and wear of movable parts and increases the machine life

SPECIFICATIONS

Machine model numbers		FPK 500	FPK 600
Working area			
Table dimensions	mm	800x400	850x450
Vertical table	mm	1.020x225	1.190x250
Table load capacity (max.)	kg	200	300
Number of T-slots	positions	6	7
T-slot (width x spacing)	mm	14x63	14x63
T-slots, vertical table (number)	positions	3	3
T-slots, vertical table (width x spacing)	mm	14x63	14x63
Travels			
Travel X-axis	mm	500	600
Travel Y-axis	mm	400	450
Travel Z-axis	mm	400	450
Milling Head			
Speed range, low	1/min	40 - 260	40 - 440
Speed range, high	1/min	260 - 2.000	440 - 2.000
Spindle speed	1/min	(2) 40 - 2.000	(2) 40 - 2.000
Spindle mount		SK 40 DIN 2080	SK 40 DIN 2080
Swivel angle	deg	90	90
Travel pinole	mm	60	60
Spindle nose-to-table distance	mm	50 - 450	50 - 500
Spindle center-to-column distance	mm	170 - 570	170 - 620
Rapid feed			
Rapid feed X-axis	mm/min	1.200	1.200
Rapid feed Y-axis	mm/min	1.200	1.200
Rapid feed Z-axis	mm/min	1.200	1.200
Horizontal Milling Spindle			
Spindle mount		SK 40 DIN 2080	SK 40 DIN 2080
Spindle center-to-table distance	mm	145 - 545	170 - 620
Feed			
Work feed X-axis	mm/min	10 - 1.000	10 - 1.000
Work feed Y-axis	mm/min	10 - 1.000	10 - 1.000
Work feed Z-axis	mm/min	10 - 1.000	10 - 1.000
Drive capacity			
Motor rating main drive	kW	3,7	5,5
Motor rating coolant pump	kW	0,13	0,13
Feed X-axis	Nm	7,7	10
Feed Y-axis	Nm	7,7	10
Feed Z-axis	Nm	10	15
Measures and weights			
Overall dimensions (L x w x h)	m	1,5x1,7x1,8	1,6x1,8x2
Weight	kg	1.550	1.750
Part No.		302353	302354

Conventional Vertical Milling Machines

FPK 4.3 • FPK 6.3 Series



The FPK 4.3 is constructed in the same stable way as the larger model

Our new generation of machine tools with automated feed and infinitely variable spindle drive

- Vertical and horizontal spindle
- Precise preloaded ball screws on all axes
- Large vertical console and work table
- Automatic feed on all axes with rapid feed
- Infinitely variable main spindle drive
- Extensive accessory package included

STANDARD EQUIPMENT

- | | |
|---------------------------------------|--|
| ✓ 3-axis position indicator X.Pos 3.2 | ✓ Counterholder for horizontal milling |
| ✓ Electronic hand-wheels | ✓ Chip tray |
| ✓ Central lubrication | ✓ Coolant system |
| ✓ Reducing sleeves MT1, MT2, MT3 | ✓ Work lamp |
| ✓ Collet chuck with collets | ✓ Pull rod (M16) for horizontal / vertical spindle |
| ✓ Horizontal milling arbor 16 mm | ✓ Levelling pads and bolts |
| ✓ Horizontal milling arbor 22 mm | ✓ Operating tools |
| ✓ Horizontal milling arbor 27 mm | ✓ Operator manual |
| ✓ Horizontal milling arbor 32 mm | |





All operator controls are arranged on one side

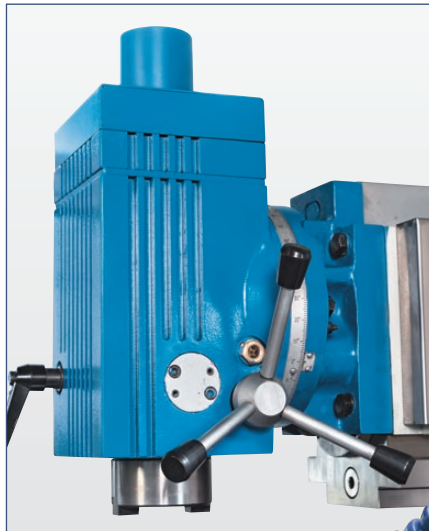

The vertical cutter head swivels, and the quill can be moved manually

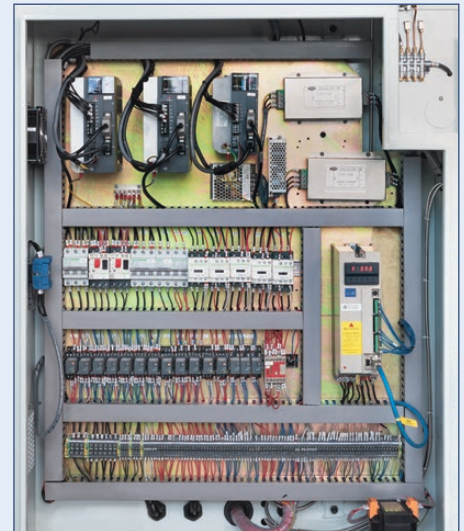

Premium electric components ensure safety and high availability

SPECIFICATIONS

Machine model numbers		FPK 4.3	FPK 6.3
Working area			
Table dimensions	mm	400x800	450x850
Vertical table	mm	225x1.020	250x1.190
Table load capacity (max.)	kg	200	300
Number of T-slots	positions	6	7
T-slot (width x spacing)	mm	14x63	14x63
T-slots, vertical table (number)	positions	3	3
T-slots, vertical table (width x spacing)	mm	14x63	14x63
Travels			
Travel X-axis	mm	500	600
Travel Y-axis	mm	400	450
Travel Z-axis	mm	400	450
Vertical Milling Spindle			
Travel pinole	mm	60	100
Spindle center - column (min.)	mm	165	165
Spindle center - column (max.)	mm	570	620
Vertical milling head			
Angular adjustment of vertical head		± 90°	± 90°
Rapid feed			
Rapid feed X-axis	mm/min	1.200	1.200
Rapid feed Y-axis	mm/min	1.200	1.200
Rapid feed Z-axis	mm/min	1.200	1.200
Feed			
Work feed X-axis	mm/min	10 - 1.000	10 - 1.000
Work feed Y-axis	mm/min	10 - 1.000	10 - 1.000
Work feed Z-axis	mm/min	10 - 1.000	10 - 1.000
Rapid feed X / Y / Z axis	mm/min	1.200	
Horizontal Milling Spindle / Vertical Milling Spindle			
Speed range	1/min	(2) 40 - 2.000	(2) 40 - 2.000
Spindle mount		SK 40 DIN 2080	SK 40 DIN 2080
Drive capacity			
Motor rating main drive	kW	3,2	5,5
Motor rating coolant pump	kW	0,09	0,09
Measures and weights			
Overall dimensions (L x w x h)	m	1,5x1,7x1,8	1,6x1,8x2
Weight	kg	1.550	1.750
Part No.		302340	302341

Conventional Vertical Milling Machines

MF 5 VP



With an infinitely variable speed the machine can be used for a wider spectrum of materials and machining processes

With large traverse paths, automatic feed in the X and Y axes, swiveling milling head and pneumatic tool clamping

- Swiveling cutter head with quill feed
- Pneumatic tool tightening system
- Infinitely variable spindle speed
- Feed on X-axis with rapid feed
- Heavy construction with wide guideways

STANDARD EQUIPMENT

- ✓ 3-axis position indicator X.Pos 3.2
- ✓ Table feed TV 1000 on X- and Y-axis
- ✓ Pneumatic tool clamping
- ✓ Chip tray
- ✓ Coolant system
- ✓ Central lubrication
- ✓ Horizontal guideway cover
- ✓ Operating tools
- ✓ Operator manual



INFO

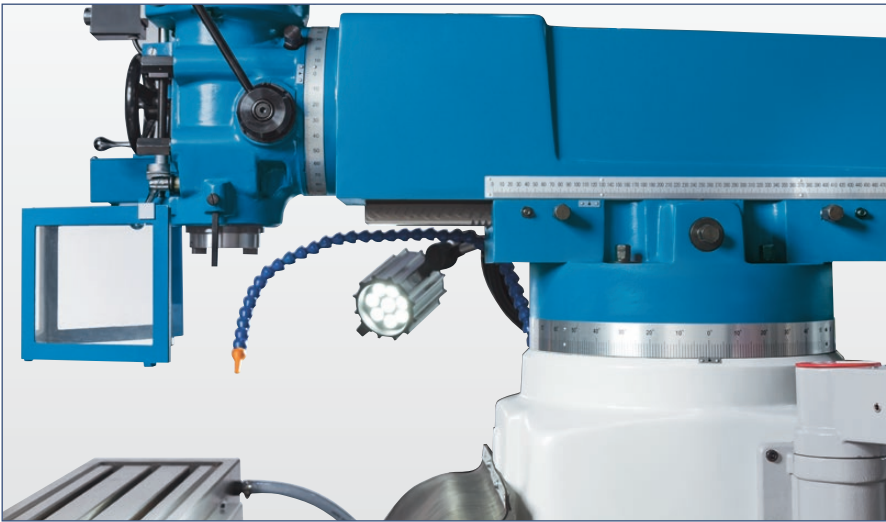

Variable throat widths and machining angles



The intuitive control panel can be positioned as needed via a cantilever support arm



Wide, rigid box ways on Z and Y-axes



X and Y axis feature automatic and rapid feed modes

SPECIFICATIONS		
Machine model numbers		MF 5 VP
Working area		
Table set up area	mm	1.370x250
Table load capacity (max.)	kg	350
Travels		
Travel X-axis	mm	800
Travel Y-axis	mm	390
Travel Z-axis	mm	380
Vertical milling head		
Spindle speed (vertical)	1/min	70 - 3.600
Spindle mount		SK 40 DIN 2080
Quill stroke	mm	127
Feed		
Quill feeds	mm/U	(3) 0,04; 0,08; 0,15
Drive capacity		
Motor rating main drive	kW	3,75
Measures and weights		
Overall dimensions (L x w x h)	m	2,54x2,16x2,24
Weight	kg	1.590
Part No.		301217

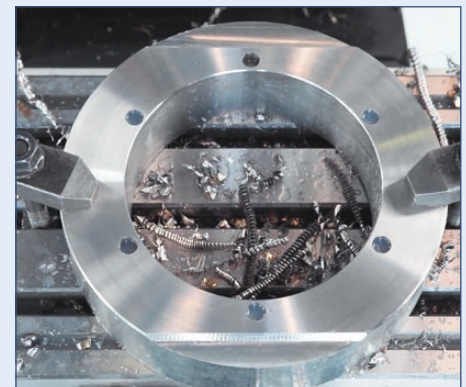

The position indicator features a bolt hole circle function. It saves time by handling complex trigonometric calculations of the individual bore positions in a circle and is easy to operate.

Conventional Vertical Milling Machines

VHF 3.2

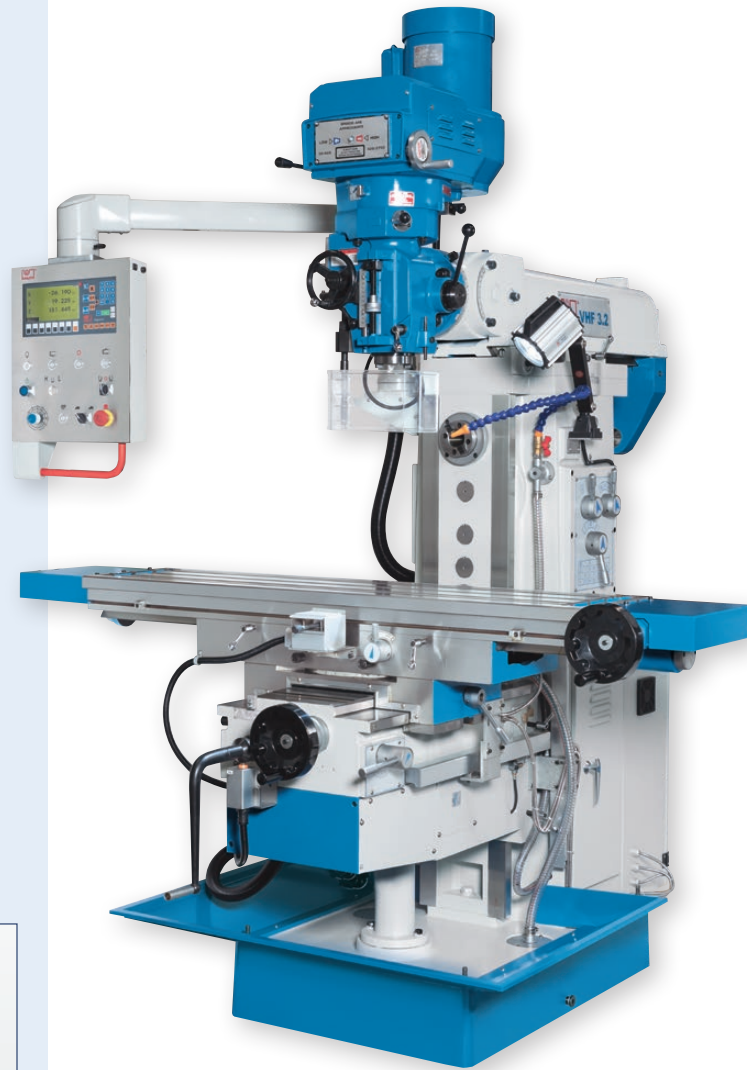

Control panel swivels for comfortable operation

With swiveling vertical milling head, automatic servo feed in all axes, horizontal spindle and swivel table

- Swiveling cutter head with automated quill feed
- Horizontal spindle with its own drive
- Swiveling milling table
- Servo-motor for infinitely variable feed on all axes
- Extensive standard equipment

STANDARD EQUIPMENT

- ✓ 3-axis position indicator X.Pos 3.2
- ✓ Chip tray
- ✓ Coolant system
- ✓ Central lubrication
- ✓ M16 draw bar
- ✓ Cutter arbor Ø 27 mm
- ✓ Operating tools
- ✓ Operator instructions



INFO



VIDEO



Long milling arbors are guided via a solid outer arbor



This knee-and-column milling machine features a large work area and high versatility for a wide variety of applications

SPECIFICATIONS		
Machine model numbers		VHF 3.2
Working area		
Table set up area	mm	1.370x320
Table load capacity (max.)	kg	300
Table swivel range r/l	Grad	45
Number of T-slots	Stück	3
T-slot (width x spacing)	mm	14x80
Travels		
Travel X-axis	mm	1.000
Travel Y-axis	mm	360
Travel Z-axis	mm	400
Vertical milling head		
Spindle mount (vertical)		SK 40 DIN 2080
Throat	mm	178 - 868
Vertical spindle-to-table surface distance	mm	160 - 560
Milling head swivel range	Grad	90
Cutter head tilt angle	Grad	45
Spindle speed (infinitely variable) (L)	1/min	70 - 450
Spindle speed (infinitely variable) (H)	1/min	450 - 3.600
Rapid feed		
Rapid feed X-/ Y-axis	mm/min	1.335
Rapid feed Z-axis	mm/min	1.000
Horizontal milling head		
Spindle speeds	1/min	(12) 35 - 1.500
Spindle mount		SK 40 DIN 2080
Horizontal spindle-to-table surface distance	mm	75 - 475
Feed		
Feed speed X-axis	mm/min	(8) 30 - 830
Feed speed Y-axis	mm/min	(8) 30 - 830
Feed speed Z-axis	mm/min	(8) 23 - 625
Drive capacity		
Main drive motor rating (vertical)	kW	3,7
Main drive motor rating (horizontal)	kW	3
Measures and weights		
Overall dimensions (L x W x H)	m	1,9x1,75x2,35
Weight	kg	1.950
Part No.		301411

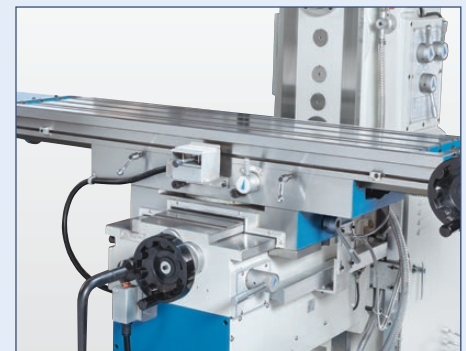

The milling table features a large setup area and can be rotated in linear direction



Horizontal spindle ensures efficient chip removal

Conventional Vertical Milling Machines

VHF 2.2



X axis with automatic feed, rapid feed, and adjustable back gauges

Universal milling machine with swiveling cutter head, automated feed in X and Y axes, horizontal spindle and extensive standard equipment

- Tilting vertical milling head
- Automatic feed in X and Y axes
- Horizontal spindle with counter holder
- Extensive package of standard accessories

STANDARD EQUIPMENT

- ✓ 3-axis position indicator X.Pos 3.2
- ✓ Coolant system
- ✓ Work lamp
- ✓ M16 draw bar
- ✓ Cutter arbor \varnothing 27 mm
- ✓ Outer arbor support for horizontal milling
- ✓ Chip tray
- ✓ Operating tools
- ✓ Operator instructions



INFO



VIDEO

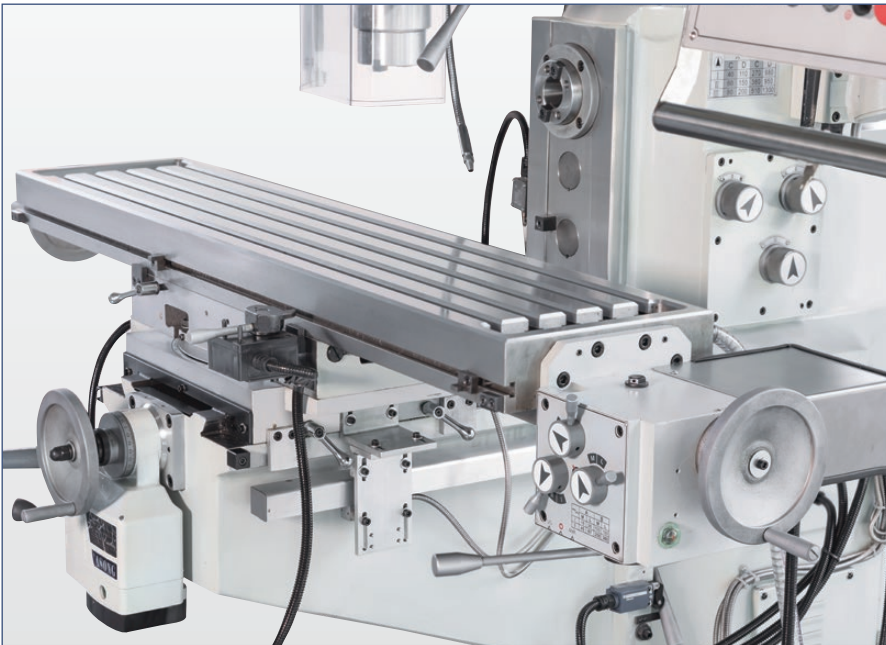

Automatic feed on X and Z axes

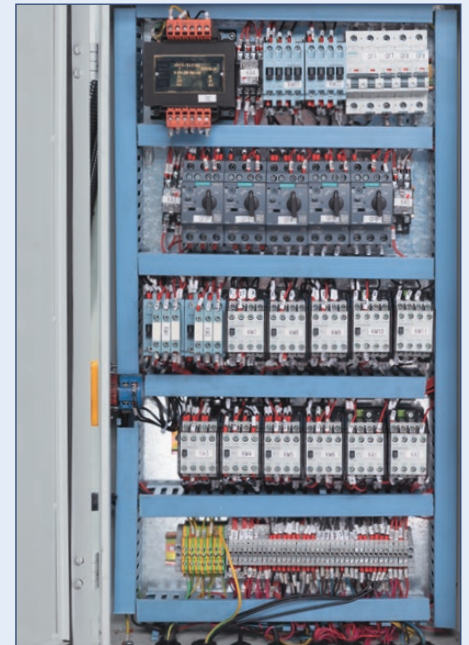

Premium components ensure maximum reliability and performance of the milling machine

SPECIFICATIONS

Machine model numbers VHF 2.2

Working area

Drilling capacity in steel	mm	30
Max. end mill diameter	mm	25
Tapping capacity, steel		M 16
Max. end face mill diameter	mm	100
Table set up area	mm	1.270x280
Table load capacity (max.)	kg	150

Travels

Travel X-axis	mm	700
Travel Y-axis	mm	210
Travel Z-axis	mm	310

Vertical milling head

Spindle speed (vertical)	1/min	(8) 115 - 1.750
Spindle mount		SK 40 DIN 2080
Quill stroke	mm	120
Throat	mm	200 - 650
Spindle nose-to-table surface distance	mm	50 - 375
Milling head swivel range	Grad	45

Rapid feed

Rapid feed Z-axis	mm/min	380
-------------------	--------	-----

Horizontal Milling Spindle

Spindle speed (horizontal)	1/min	(12) 40 - 1.300
Spindle mount		ISO 40
Horizontal spindle-to-table surface distance	mm	0 - 310

Feed

Feed speed X-axis	mm/min	16 - 380
Feed speed Y-axis	mm/min	0 - 700

Drive capacity

Motor rating horizontal spindle	kW	2,2
Motor rating vertical spindle	kW	0,85 - 1,5

Measures and weights

Overall dimensions (l x w x h)	m	1,7x1,45x2,45
Weight	kg	1.400
Part No.		362651



The milling table features a large setup area



Vertical and horizontal spindle each have their separate drive

Conventional Vertical Milling Machines

VHF 1.1

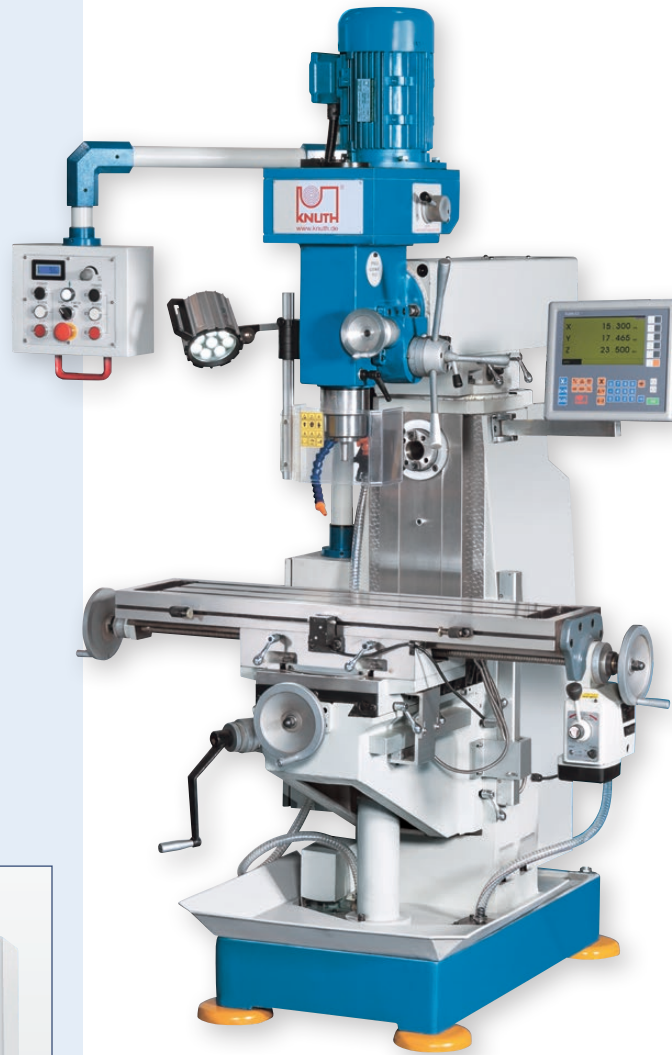

User-friendly intuitive control panel with speed indicator

Console milling machine with swiveling milling head, automatic feed in the X-axis, horizontal spindle and swivel table

- Universal cutter head with manual quill feed
- Horizontal milling spindle with its own drive
- Infinitely variable spindle speed
- Feed on X-axis
- Extensive standard equipment



INFO



VIDEO

STANDARD EQUIPMENT

- ✓ 3-axis position indicator X.Pos 3.2
- ✓ 2 long cutter arbors (Ø22, Ø27 mm)
- ✓ Drill chuck 16 mm
- ✓ Reducing sleeve ISO 40 / MT3 and ISO 40 / MT2
- ✓ Coolant system
- ✓ Work lamp,
- ✓ Operating tools
- ✓ Operator instructions



Solid top beam with outer arbor allows rigid mounting of long milling arbors

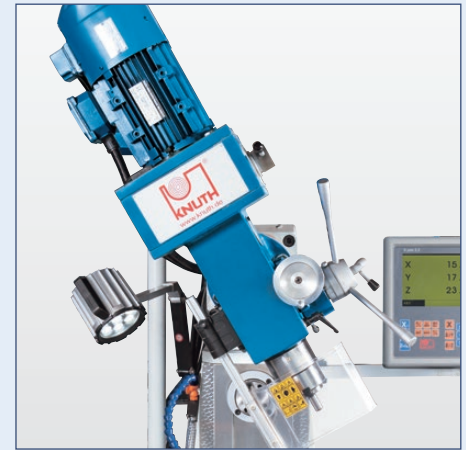

Swiveling cutter head with sliding quill



Cutter table swivels in X axis



Automatic feed and rapid feed are infinitely variable and provided with adjustable back gauges

SPECIFICATIONS		
Machine model numbers		VHF 1.1
Working area		
Drilling capacity	mm	25
Milling diameter in steel (max.)	mm	18
Table set up area	mm	1.000x240
Table load capacity (max.)	kg	150
Table angle adjustment max. (left/right)		30°/40°
Travels		
Travel X-axis	mm	535
Travel Y-axis	mm	160
Travel Z-axis	mm	300
Vertical milling head		
Spindle speed (vertical)	1/min	100 - 2.000
Spindle mount		SK 40 DIN 2080
Quill stroke	mm	120
Throat	mm	200 - 700
Spindle nose-to-table surface distance	mm	65 - 385
Horizontal Milling Spindle		
Spindle speed (horizontal)	1/min	(9) 60 - 1.350
Horizontal spindle-to-table surface distance	mm	0 - 300
Drive capacity		
Motor rating horizontal spindle	kW	2,2
Motor rating vertical spindle	kW	1,5
Measures and weights		
Overall dimensions (L x w x h)	m	1,38x1,22x2,15
Weight	kg	1.000
Part No.		362665



A hand-wheel for micro-adjustments allows precise quill positioning



Premium components ensure maximum reliability and performance of the milling machine

SBF 40 TV 1000

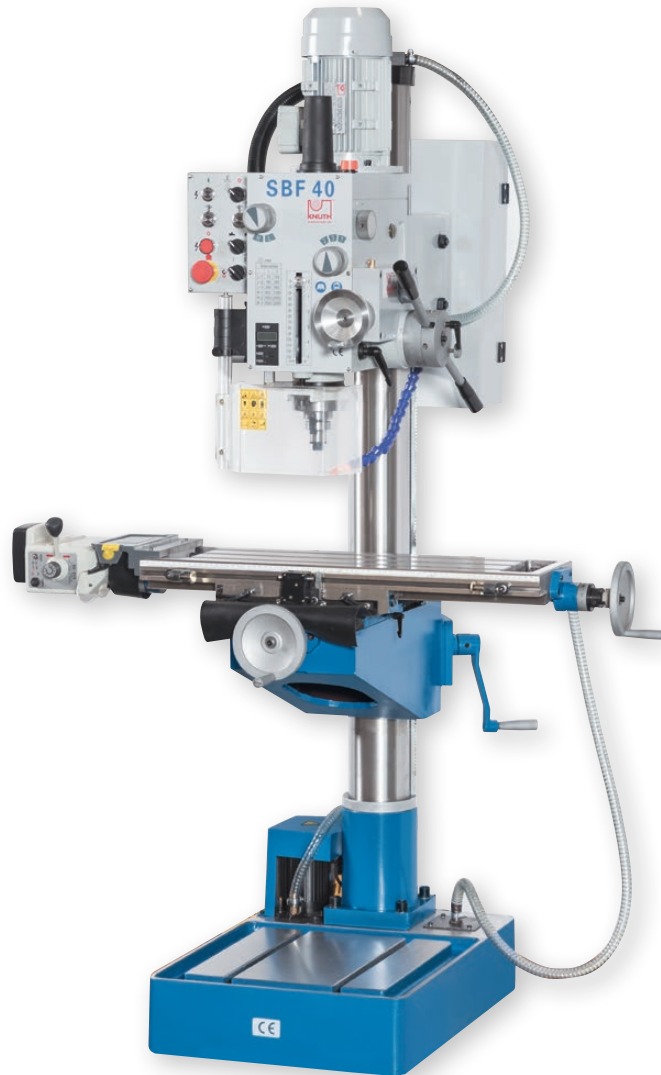

Infinitely variable milling table feed

Universal milling/drilling machine with automated drilling feed, compound sliding table with driven X axis and swiveling gear head

- Infinitely variable feed on X axis
- Automated drilling feed with depth display
- Gearbox milling head for powerful machining
- Swiveling head for wide range of applications



INFO

STANDARD EQUIPMENT

- | | |
|---------------------------|--------------------|
| ✓ Thread cutting function | ✓ Tool-holder bits |
| ✓ Table feed TV 1000 | ✓ Coolant system |
| ✓ Draw bar | ✓ Operator manual |
| ✓ Drill chuck | |

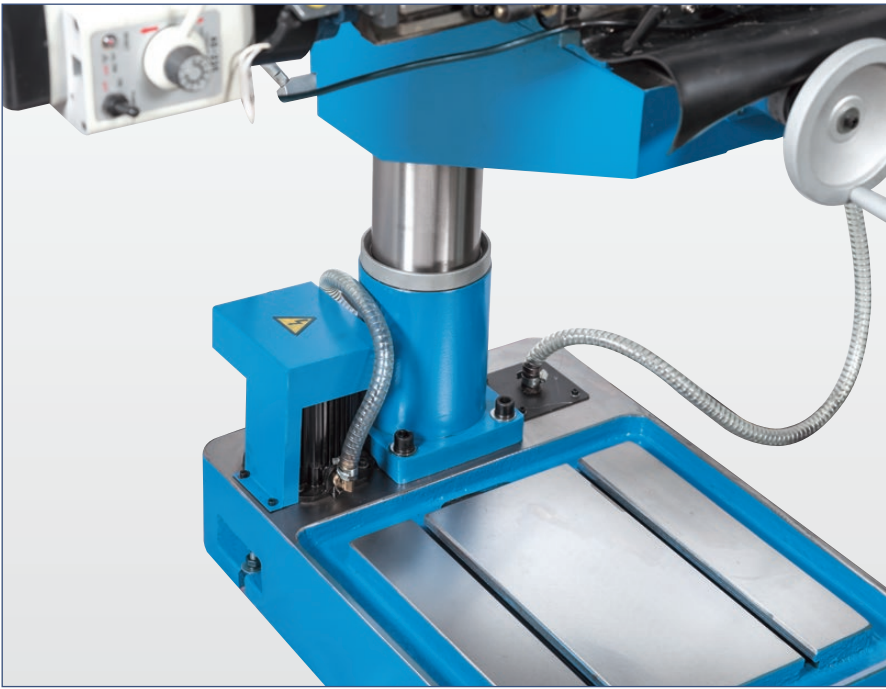

Coolant system with reservoir integrated into machine foot



Automatic quill feed with 3-step gears

SPECIFICATIONS

Machine model numbers		SBF 40
Working area		
Table set up area	mm	730x210
Table load capacity (max.)	kg	100
Number of table T-slots	positions	3
T-slot table (width x spacing)	mm	14x63
T-slot foot (qty)	positions	2
T-slot foot (width x spacing)	mm	14x200
Quill stroke	mm	120
Throat depth	mm	278
Column diameter	mm	115
Spindle nose-to-table surface distance	mm	600
Spindle nose-to-foot distance	mm	1.180
Drilling capacity in steel / ST37	mm	40
Head swivel range		± 45°
Travels		
Travel X-axis	mm	500
Travel Y-axis	mm	190
Z1 / Z2 axis travel	mm	530
Headstock		
Speed range	1/min	(12) 75 - 3.200
Spindle mount		MK 4 DIN 228
Rapid feed		
Rapid feed	mm/min	600
Feed		
Work feed	mm/min	0 - 420
Drive capacity		
Main motor rating	kW	1,5 / 1,1
Motor rating coolant pump	kW	0,04
Measures and weights		
Overall dimensions (length x width x height)	m	0,83x0,76x1,85
Weight	kg	390
Part No.		101573

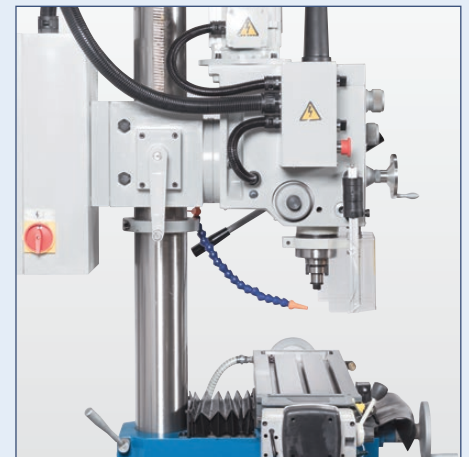

Gear head and table are vertically adjustable



Gear head swivels to both sides

Drill Press/Milling Machines

Mark Super Series



Gear head swivels to both sides



User-friendly intuitive control panel with speed indicator



Multi-side milling/drilling machine with automated feed in the X axis, automated quill feed and tapping unit

- Infinitely variable feed on X axis
- Automated drilling feed with depth display
- Gearbox milling head for powerful machining
- Swiveling head for wide range of applications
- Infinitely variable spindle speed with digital display (SV model only)

STANDARD EQUIPMENT

- | | |
|---------------------------------------|---------------------|
| ✓ 3-axis position indicator X.Pos 3.2 | ✓ Drill chuck 13 mm |
| ✓ Automatic quill feed | ✓ Tool-holder bits |
| ✓ Base | ✓ Operator manual |
| ✓ Table feed TV 1000 | |



Drilling at an angle



Inside turning



Shell end mills

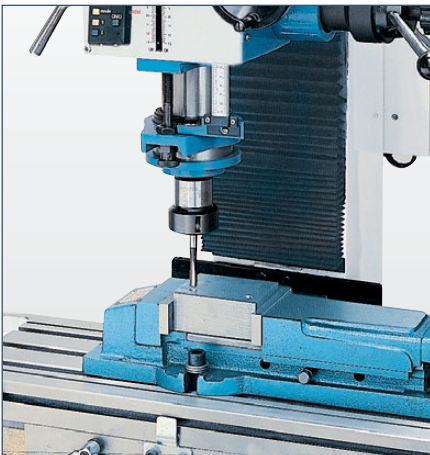

Tapping

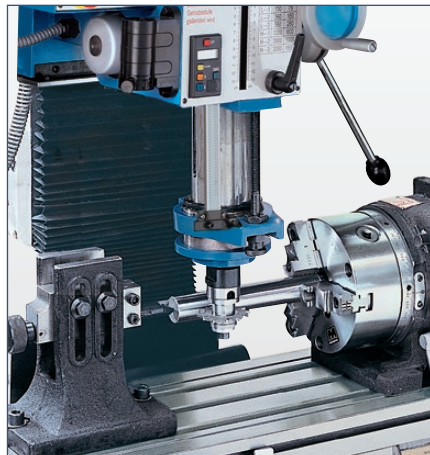

Divider and tailstock

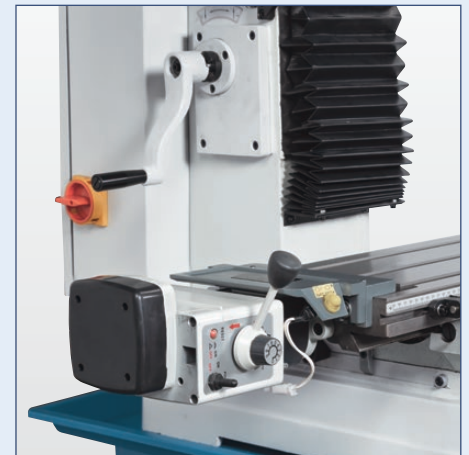

Automatic feed and rapid feed

SPECIFICATIONS

Machine model numbers		Mark Super SV	Mark Super S
Working area			
Table dimensions	mm	800x240	800x240
Drilling capacity in steel	mm	25	32
Shaft milling	mm	25	32
Head elevation	mm	380	350
Number of table T-slots	positions	3	3
T-slot table (width x spacing)	mm	14x80	14x80
Travels			
Travel X-axis manual / autom.	mm	560 / 480	560 / 480
Travel Y-axis	mm	190	190
Vertical milling head			
Spindle mount		MK 4 DIN 228	MK 4 DIN 228
Quill diameter	mm	75	75
Quill stroke	mm	120	120
Spindle nose-to-table distance	mm	450	460
Throat	mm	258	258
Head swivel range		± 45°	± 45°
Speed	1/min	(2) 75-438 / 438-2500	(12) 75-3200
Drive capacity			
Main motor rating	kW	1,5	1,5 / 1,1
Measures and weights			
Overall dimensions (length x width x height)	m	1,24x0,93x2,1	1,25x0,95x2,13
Weight	kg	380	380
Part No.		301490	301498

Drilling Accessories



Drill Chucks



The drill chuck ensures secure clamping of cylindrical drilling tools for the machining of cast-iron, steel, and non-ferrous metals. These are suitable for the full application spectrum of stationary drill presses, lathes, and milling machines, whether conventional or CNC type.

KNUTH drill chucks have a proven record in everyday use in production facilities and workshops and are known for their long life and high reliability. Taper mandrels with Morse taper or taper shank ensure that these drill chucks will fit virtually all common machine tools. We also offer suitable mounts and thread cutters for tap grinders.



Drilling Tools



With a drilling tool that matches the machine and the material, boreholes can be accurately created and processed. It is important that the design of the tools is optimally adapted to the material in order to ensure a long service life and high production quality. In addition, we also offer tools for machining blind or through holes, such as various countersink types or adjustable reamers.



Vises

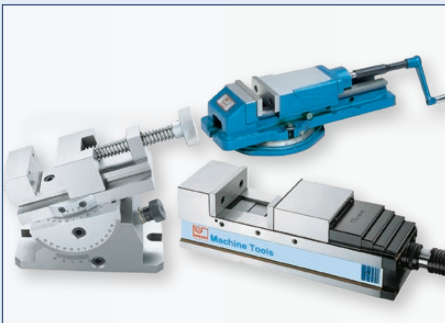

Workpieces must be held firmly on the machine table. For small and medium workpieces, a vise is the optimum solution for a firm hold and precise angular and parallel clamping. The machine or milling vise must be matched to the application to provide the required high stability and clamping force to withstand the strong vibrations and lateral forces that are exerted on the workpiece during machining. For drilling operations axial forces are the greatest concern, while for grinding and electric discharge machining maximum precision is top priority.



Clamping Kits

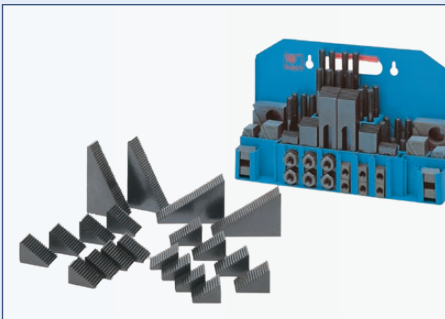

Milling machines and drill presses are equipped with work tables and setup areas with T-slots. To fix workpieces, dividers, clamping devices on the table, the user will need an assortment of clamping devices. We offer T-slot nuts, clamping bolts, step blocks, and lever clamping straps, both individually or in sets. These items simplify preparation tasks, shorten tooling times and are part of the basic equipment of every machine tool.



The new KNUTH Accessory Shop is now live! → [Shop now](#)

Drilling Machines



Radial Drilling Machines from Page 62



Quick Radial Drilling Machines Page 68/69



Column Drilling Machines from Page 70



Table Drilling Machines from Page 82

Radial Drilling Machines R-VT PRO Series

NEW

3
Year
Warranty

on the **Touchscreen**

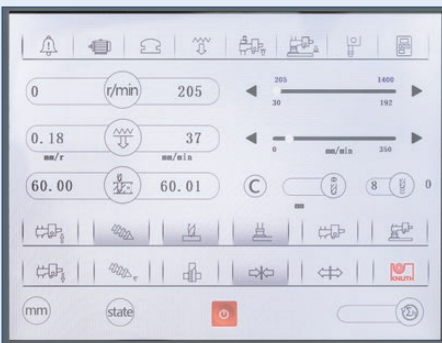

Electronically controlled servo quill feed with large touchscreen display



INFO

Servo-conventional radial drilling machine with advanced functions and large touchscreen

- Unique operating concept
- Advanced control of machine functions
- Servomotor-driven quill feed
- Rigid design with proven high stability
- **3-year Warranty on the Touchscreen**

STANDARD EQUIPMENT

- ✓ Touchscreen control panel
- ✓ Automatic thread cutting cycles
- ✓ Servo motor for quill feed
- ✓ Accessory set for drilling
- ✓ Cube table
- ✓ Manual central lubrication
- ✓ Coolant system
- ✓ Work light
- ✓ Height adjustable spindle cover
- ✓ Operator instructions



Swivel axis and travel axis feature extremely smooth operation to make the operator's everyday production work easier



Drill head and column can be clamped/ released together or separately



The rugged LED work light, with protection from sprayed water, is bright, energy-efficient, and promotes safe and productive work

SPECIFICATIONS

Machine model numbers		R 40 VT PRO	R 60 VT PRO	R 80 VT PRO
Working area				
Drilling capacity	mm	40	60	80
Drilling capacity, cast iron	mm	52	70	105
Tapping capacity, cast-iron		M 40	M 50	M 60
Tapping capacity, steel		M 32	M 45	M 52
Drilling depth (max.)	mm	250	315	400
Throat depth	mm	300 - 1.300	350 - 1.600	465 - 2.550
Spindle nose-to-table surface distance	mm	300 - 1.200	350 - 1.250	360 - 1.560
Drill head travel (horizontal)	mm	1.000	1.250	2.095
Headstock				
Speed range	1/min	(2) 74 - 2.200	(2) 38 - 2.000	(2) 30 - 1.400
Spindle mount	MT	4	5	6
Feed				
Feeds	mm/min	0 - 300	0 - 300	0 - 350
Drive capacity				
Motor rating main drive	kW	2,2	4	7,5
Stroke motor	kW	1,1	1,5	2,6
Measures and weights				
Overall dimensions (l x w x h)	m	2,07x1,02x2,51	2,49x1,05x2,78	3,59x1,25x3,56
Weight	kg	2.300	3.800	7.400
Part No.		101601	101603	101602

Radial Drilling Machines

R-V Series



The R-V Series combines high drilling capacity and large throat with easy handling

Infinitely variable spindle speed, feed gear and a wide range of sizes characterise our proven bestseller series

- Infinitely variable spindle speed with digital display
- A cube table offers extended clamping possibilities
- Robust construction for constant high accuracy
- Modern design for easy and comfortable operation



INFO



VIDEO

STANDARD EQUIPMENT

- ✓ Coolant system
- ✓ Cube table
- ✓ LED work lamp
- ✓ Operator instructions



Adjustable boring depth stop with large, easy to read scale and Nonius



Infinitely variable spindle speed and easy to read digital display

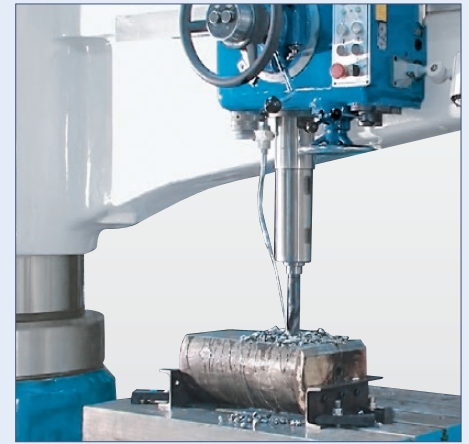

An adjustable overload clutch protects workpieces and machine from damages

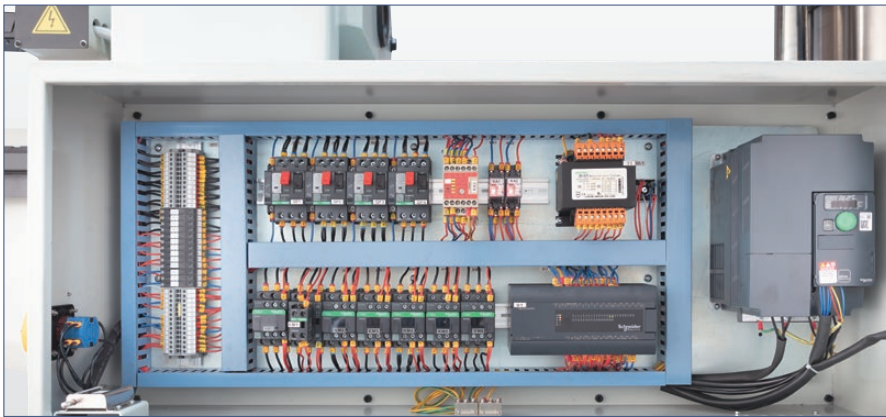

The control cabinet is integrated into the radial drill press for optimum protection of premium components



A central lubrication system ensures reliable lubrication of the column

SPECIFICATIONS

Machine model numbers		R 40 V	R 60 V	R 80 V
Working area				
Drilling capacity	mm	40	60	80
Tapping capacity, cast-iron		M 40	M 52	M 60
Tapping capacity, steel		M 32	M 40	M 52
Drilling depth (max.)	mm	260	315	400
Machine table dimensions	mm	2.050x920x180	2.400x1.000x200	3.380x1.230x280
Cube table dimensions	mm	620x450x450	750x500x500	580x850x500
Throat depth	mm	300 - 1.300	350 - 1.600	450 - 2.550
Spindle nose-to-table surface distance	mm	300 - 1.200	350 - 1.250	400 - 1.580
Arm stroke (vertical)	mm	640	585	800
Column diameter	mm	280	350	450
Travels				
Drill head travel (horizontal)	mm	1.000	1.250	2.100
Headstock				
Speed range	1/min	54 - 2.150	38 - 2.000	30 - 1.400
Spindle mount	MT	4	5	6
Feed				
Feeds	mm/U	0,1 - 0,63	0,06 - 1	0,06 - 1,38
Drive capacity				
Motor rating main drive	kW	2,2	4	7,5
Stroke motor	kW	1,1	1,5	2,2
Measures and weights				
Overall dimensions (L x w x h)	m	2,07x0,85x2,43	2,49x1,05x2,78	3,59x1,25x3,53
Weight	kg	2.300	3.800	7.400
Part No.		101557	101649	101558

Radial Drilling Machines

R 32 Basic



Compact radial drilling machine with a large throat, manual axis clamping and automatic quill feed

- Easy positioning on all axes
- Motorized height adjustment of the boom
- Spindle made of premium hardened steel
- Mechanical clamping for head, column, and arm



INFO



VIDEO

STANDARD EQUIPMENT

- ✓ Coolant system
- ✓ Halogen lights
- ✓ Cube table
- ✓ Operator instructions



For Drilling, Reaming and Tapping



Hand-lever for quill feed is used to control the automatic feed



Rigid column base with central main switch



Swiveling boom for large throat widths

SPECIFICATIONS		
Machine model numbers		R 32 Basic
Working area		
Drilling capacity	mm	32
Column diameter	mm	200
Throat depth	mm	320 - 820
Spindle nose-to-table surface distance	mm	320 - 860
Cube table dimensions	mm	400x400x350
Machine table dimensions	mm	1.370x700x160
Quill stroke	mm	240
Headstock		
Spindle mount	MT	4
Speed range	1/min	(6) 75 - 1.220
Feed		
Feeds	mm/U	(3) 0,1 - 0,25
Drive capacity		
Motor rating main drive	kW	1,5
Measures and weights		
Overall dimensions (L x w x h)	m	1,41x0,72x1,89
Weight	kg	1.180
Part No.		101522



Mechanical clamping for head, column, and arm

Radial Drilling Machines

KSR 50 VT



on the **Touchscreen**

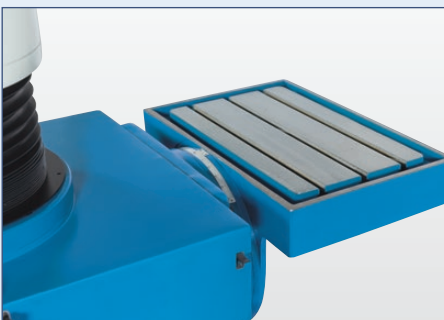

Swivel and angle tables for a wide variety of clamping options

Fast smooth positioning of the drilling quill on 3 possible workstations, with servo quill feed and infinitely variable spindle speed, large touchscreen control panel and extra drilling power

- Unique operating concept
- 3 work stations
- Expanded control of machine functions
- Servomotor-driven quill feed
- Linear guides for smooth, high-precision movement of the arm
- **3-year Warranty on the Touchscreen**

STANDARD EQUIPMENT

- ✓ Touchscreen monitor
- ✓ Additional setup areas at the side and rear
- ✓ Cube table
- ✓ Swivelling horizontal table
- ✓ Work lamp
- ✓ Coolant system
- ✓ Thread cutting function
- ✓ Reduction sleeves
- ✓ Operating tools
- ✓ Operator manual



INFO



VIDEO



The high-resolution touchscreen features a scratch-resistant surface. Matching rpm and feed speeds for each drill can be recalled from a database and automatically applied.



All machine functions are controlled and displayed on the touchscreen

SPECIFICATIONS		
Machine model numbers		KSR 50 VT
Working area		
Drilling capacity	mm	50
Tapping capacity, steel		M 32
Throat depth	mm	960
Spindle nose-to-table surface distance	mm	760
Head swivel range		± 90°
Column diameter	mm	220
Table set up area	mm	1.200x505
Column stroke	mm	400
Quill stroke	mm	200
Travels		
Upper beam travel	mm	590
Headstock		
Spindle mount	MT	4
Spindle speed (infinitely variable)	1/min	50 - 2.000
Feed		
Feeds	mm/min	1 - 300
Drive capacity		
Motor rating main drive	kW	3
Motor rating height adjustment	kW	1,5
Motor rating feed	kW	1,26
Motor rating hydraulic pump	kW	0,37
Motor rating coolant pump	kW	0,085
Measures and weights		
Overall dimensions (L x w x h)	m	1,72x1,2x2,25
Weight	kg	2.740
Part No.		162365

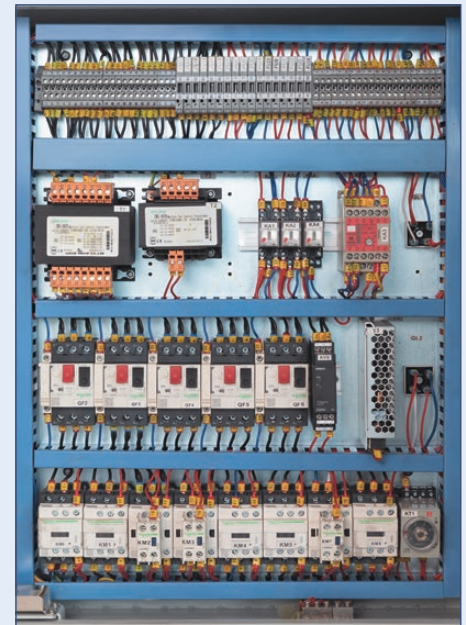

Premium electric components

Column Drilling Machines SSB 70 Xn Advanced

NEW

3
Year
Warranty

on the **Touchscreen**



Modern operating concept with rugged touchscreen display

Heavy drill press with high drilling power, touchscreen and motorized table height adjustments

- High drilling power
- Touchscreen control panel
- Precision-stepped gear drive
- Quill feed shifted via manual transmission
- Motorized table height adjustment
- Work table swivels and rotates
- **3-year Warranty on the Touchscreen**

STANDARD EQUIPMENT

- | | |
|-------------------------------------|-------------------------|
| ✓ Control panel with touchscreen | ✓ Coolant system |
| ✓ Thread cutting function | ✓ Protective shield |
| ✓ Automatic spindle feeds | ✓ LED work lamp |
| ✓ Motorised table height adjustment | ✓ Operator instructions |
| ✓ Accessory set for drilling | |



INFO

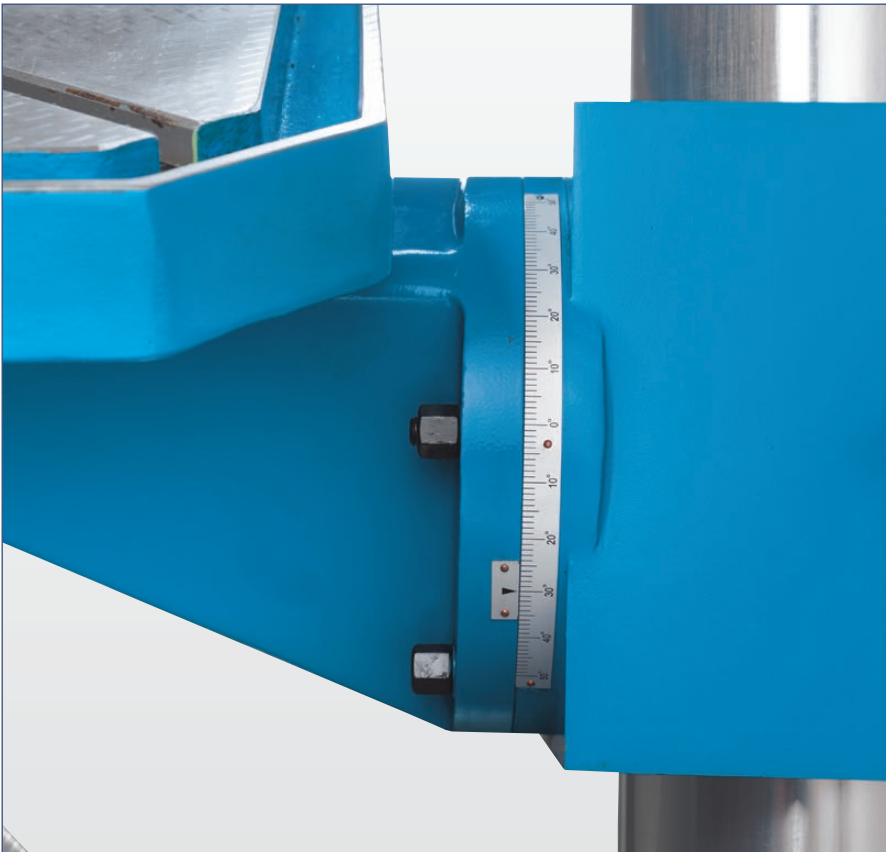

A large scale is provided for easy and exact angle table positioning



The large work table with diagonal chip flutes can be rotated and swiveled

SPECIFICATIONS

Machine model numbers **SSB 70 Xn Advanced**

Working area

Drilling capacity	mm	70
Tapping capacity, steel		M 50
Table set up area	mm	600x600
Manual table travel	mm	690
Powered table travel	mm	600
Table swivel range (max.)		± 45°
Quill stroke	mm	270
Column diameter	mm	220
Spindle nose-to-table surface distance manual	mm	792
Spindle nose-to-table surface distance motorised	mm	740
Spindle nose-to-foot distance	mm	1.375
Throat depth	mm	420
T-slots, width	mm	16
Number of T-slots	positions	2

Headstock

Spindle mount	MT	5
Speed range	1/min	(12) 38 - 1.230

Feed

Quill feeds	mm/U	0,1- 0,4
-------------	------	----------

Drive capacity

Motor rating main drive	kW	5,5
-------------------------	----	-----

Measures and weights

Overall dimensions (L x w x h)	m	1,22x0,65x2,82
Weight	kg	980
Part No.		101681

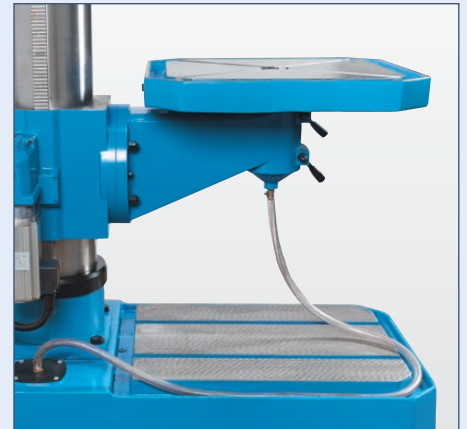

A high-performance coolant system is part of the standard equipment

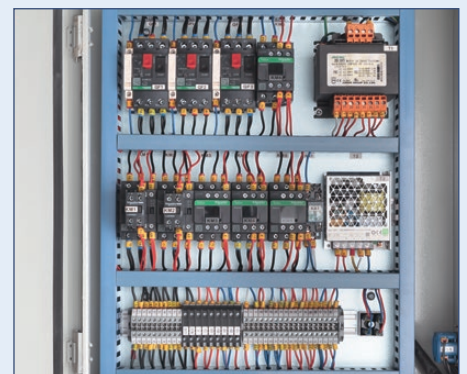

Premium components ensure maximum reliability and performance of the drill press

Column Drilling Machines

SSB F 60 Super VT PRO

3
Year
Warranty

on the **Touchscreen**



Very heavy construction with thick-walled column



Powerful drill with touchscreen control panel, servo quill feed with advanced functions

- High drilling and thread cutting capacity
- Servo motor for quill feed
- Touchscreen control panel with additional features
- Infinitely variable speed
- Motorized table height adjustments
- Swiveling and rotating setup table
- **3-year Warranty on the Touchscreen**



Touchscreen control panel with extended functions



STANDARD EQUIPMENT

- | | |
|-------------------------------------|-------------------------|
| ✓ Touchscreen controller | ✓ Coolant system |
| ✓ Automatic thread cutting cycles | ✓ Protective shield |
| ✓ Automatic drilling feed | ✓ LED work lamp |
| ✓ Motorised table height adjustment | ✓ Operator instructions |
| ✓ Accessory set for drilling | |



Electronically controlled servo quill feed with thread cutting function

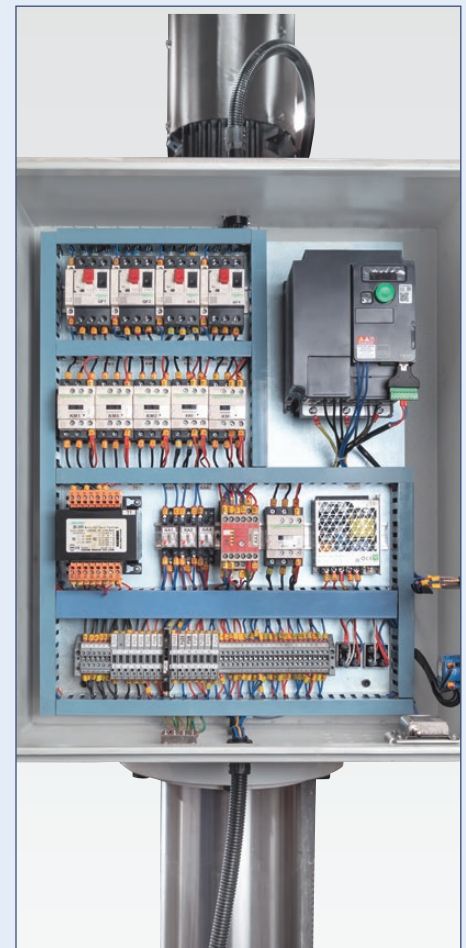

Premium components ensure maximum reliability and performance of the drill press

SPECIFICATIONS		
Machine model numbers		SSB F 60 Super VT PRO
Working area		
Drilling capacity	mm	60
Tapping capacity, steel		M 42
Table set up area	mm	600x500
Quill stroke	mm	200
Table swivel range (max.)		± 45°
Table stroke	mm	528
Column diameter	mm	200
Throat depth	mm	370
Spindle nose-to-foot distance	mm	1.123
Spindle nose-to-table surface distance	mm	520
Headstock		
Speed range	1/min	50 - 316, 316 - 2000
Spindle mount	MT	5
Feed		
Quill feeds	mm/U	stufenlos
Drive capacity		
Motor rating main drive	kW	4
Motor rating for vertical table travel	kW	0,37
Motor rating coolant pump	kW	0,16
Measures and weights		
Overall dimensions (L x w x h)	m	1,04x0,6x2,27
Weight	kg	950
Part No.		101680



Large drill press table with circumferential coolant groove and ± 45° swivel range



Large throat and work table that swivels and rotates



Drill press 2.0 - all functions on a rugged touchscreen



Column Drilling Machines SSB F Super VT Series



on the **Touchscreen**



SSB 50 F Super VT

Drill presses with touchscreen, modern inverter technology, and motorized table height adjustment

- Touchscreen control panel with extra functions
- Automatic feed with manual transmission
- Infinitely variable speed control
- Motorized table height adjustment
- Swiveling and rotating work table
- **3-year Warranty on the Touchscreen**

STANDARD EQUIPMENT

- ✓ Touchscreen controller,
- ✓ Thread cutting function
- ✓ Automatic spindle feeds
- ✓ Motorised table height adjustment
- ✓ Accessory set for drilling
- ✓ Coolant system
- ✓ Protective shield
- ✓ LED work lamp
- ✓ Operator instructions



The wide speed range is controlled in two gear steps via inverter

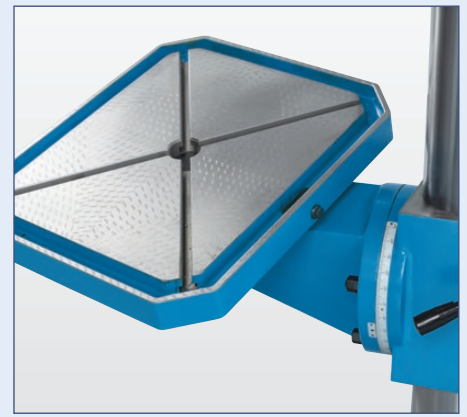

The large work table with diagonal chip flutes can be rotated and swiveled

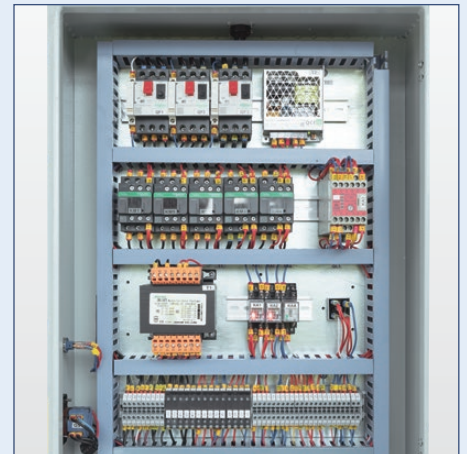

Premium components ensure maximum reliability and performance of the drill press

SPECIFICATIONS

Machine model numbers		SSB 40 F Super VT	SSB 50 F Super VT
Working area			
Drilling capacity	mm	40	50
Tapping capacity, steel		M 24	M 30
Table set up area	mm	540x440	580x460
Quill stroke	mm	190	200
Manual table travel	mm	540	515
Powered table travel	mm	430	405
Table swivel range (max.)		± 50°	± 50°
Column diameter	mm	140	180
Spindle nose-to-table surface distance	mm	595	575
Spindle nose-to-foot distance	mm	1.195	1.165
Throat depth	mm	340	360
Table load capacity	kg	120	
Headstock			
Speed range	1/min	60 - 2.600	50 - 2.000
Spindle mount	MT	4	4
Feed			
Quill feeds	mm/U	0,1, 0,2, 0,3, 0,4	0,08; 0,12; 0,17; 0,24; 0,35; 0,50
Drive capacity			
Motor rating main drive	kW	2	3
Measures and weights			
Overall dimensions (length x width x height)	m	0,88x0,64x2,23	0,97x0,68x2,34
Weight	kg	565	720
Part No.		162334	101679

Column Drilling Machines

SSB Xn Serie



SSB 40 Xn shown



The SSB 32 Xn drill head swivels $\pm 45^\circ$ to the left and right and its height is adjustable

Our best selling, gear driven drill press for your workshop

- Tilting table for drilling at an angle
- Automatic drilling feed
- Work table with 2 axes of rotation for flexibility in operation
- Well-considered safety protection
- Integrated coolant system

STANDARD EQUIPMENT

- ✓ Thread cutting function
- ✓ Automatic drilling feed
- ✓ Accessory set for drilling
- ✓ Coolant system
- ✓ Protective shield
- ✓ LED work lamp
- ✓ Operator instructions





The 3-step feed gear is integrated in the drill head, runs in an oil bath for low maintenance and is easy to shift



Large drill press table with adjustable angle

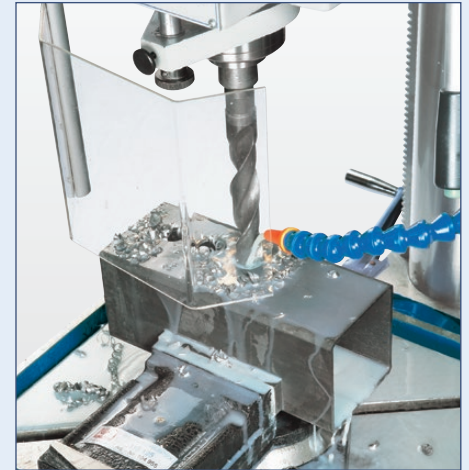

Coolant system is included

SPECIFICATIONS

Machine model numbers		SSB 32 Xn	SSB 40 Xn
Working area			
Drilling capacity	mm	32	40
Tapping capacity, steel		M 20	M24
Table set up area	mm	500x420	540x440
Manual table travel	mm	490	550
Quill stroke	mm	160	190
Table swivel range (max.)		± 45°	± 45°
Spindle nose-to-table surface distance	mm	630	610
Spindle nose-to-foot distance	mm	1.185	1.195
Throat depth	mm	320	340
Column diameter	mm	120	140
Head swivel range		± 50°	-
Table load capacity	kg	100	150
Headstock			
Spindle mount	MT	4	4
Speed range	1/min	(12) 125 - 3.030	(12) 75 - 2.020
Feed			
Quill feeds	mm/U	0,1; 0,2; 0,3	0,12; 0,24; 0,4
Drive capacity			
Motor rating main drive	kW	1,2	1,5
Measures and weights			
Overall dimensions (length x width x height)	m	0,84x0,5x1,96	0,95x0,61x2,23
Weight	kg	540	550
Part No.		162302	162303

Column Drilling Machines

KB 32 SFV PRO



Rigid design with extended working height

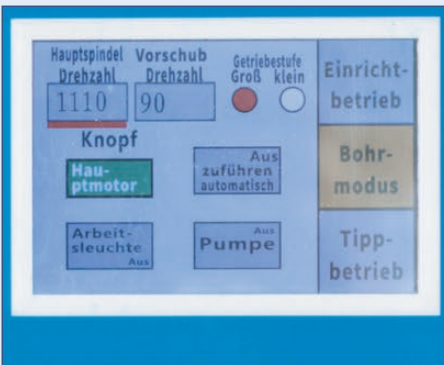

Modern operating concept with rugged touchscreen display

Top model of the KB drilling machines with infinitely variable speed adjustment, automatic feed and touchscreen control panel

- Automatic feed
- Touchscreen
- Thread cutting unit

STANDARD EQUIPMENT

- ✓ Touchscreen control panel
- ✓ Automatic quill feed
- ✓ LED work lamp
- ✓ Coolant system
- ✓ Drill chuck
- ✓ Tool-holder bits
- ✓ Drill press vise
- ✓ Thread cutting function
- ✓ Operating tools
- ✓ Operator manual



INFO



Feed motor continuously adjustable

Infinitely variable feed motor

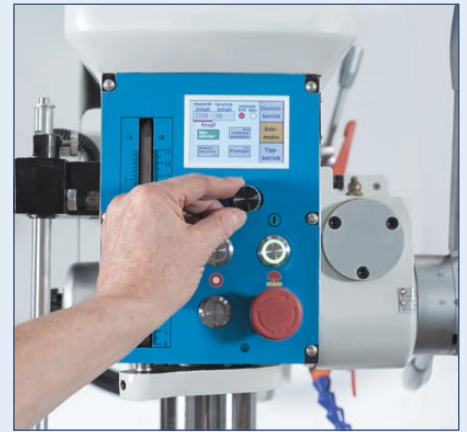

Spindle speed infinitely variable



Coolant system is integrated in the machine base



Dual table clamping for guaranteed stability

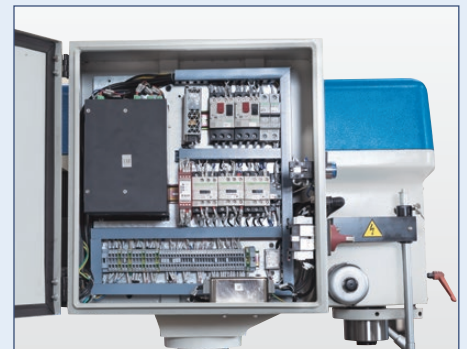

Premium components ensure high reliability and powerful performance

SPECIFICATIONS

Machine model numbers		KB 32 SFV PRO
Working area		
Drilling capacity	mm	32
Tapping capacity, steel		M24
Table set up area	mm	330x330
Quill stroke	mm	150
Column diameter	mm	100
Throat depth	mm	245
Spindle nose-to-foot distance	mm	1.235
Spindle nose-to-table surface distance	mm	800
Table load capacity	kg	50
Headstock		
Speed range, high	1/min	400 - 2.250
Speed range, low	1/min	140 - 400
Spindle mount	MK	3
Feed		
Quill feed	mm/min	24 - 243
Drive capacity		
Motor rating main drive	kW	3
Motor rating coolant pump	kW	0,04
Measures and weights		
Overall dimensions (L x w x h)	m	0,9x0,6x1,9
Weight	kg	310
Part No.		170464

Bench-Mounted Column Drill Press

KB 32 SF



Digital speed indicator and integrated work light included in standard equipment



High-quality bench and column drill press for industrial applications

- Compact and powerful
- Digital speed display
- Tapping feature
- Integrated work light
- Delivered with drill chuck and vise

STANDARD EQUIPMENT

- ✓ Coolant system
- ✓ Drill chuck
- ✓ Tool-holder bits
- ✓ Drill press vise
- ✓ Thread cutting function
- ✓ Operating tools



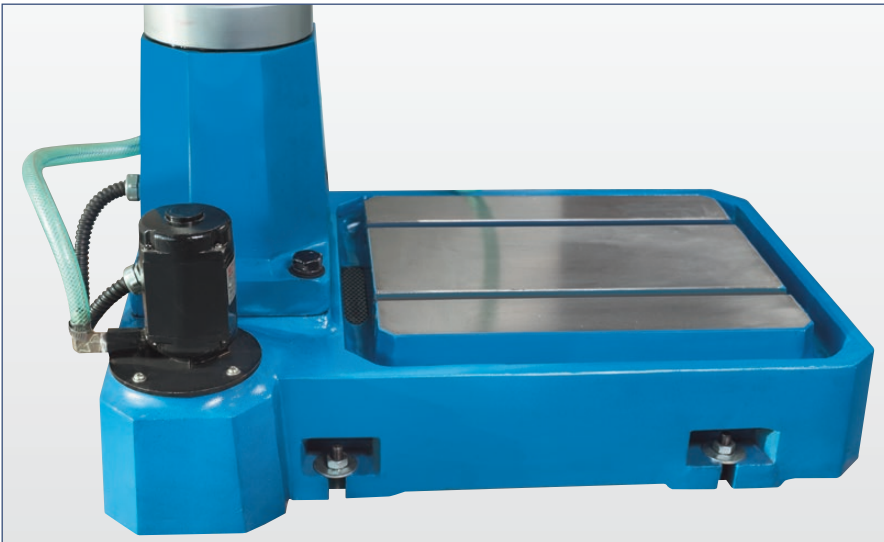

Coolant system is integrated in the machine base



The drill press table is fixated via double clamps

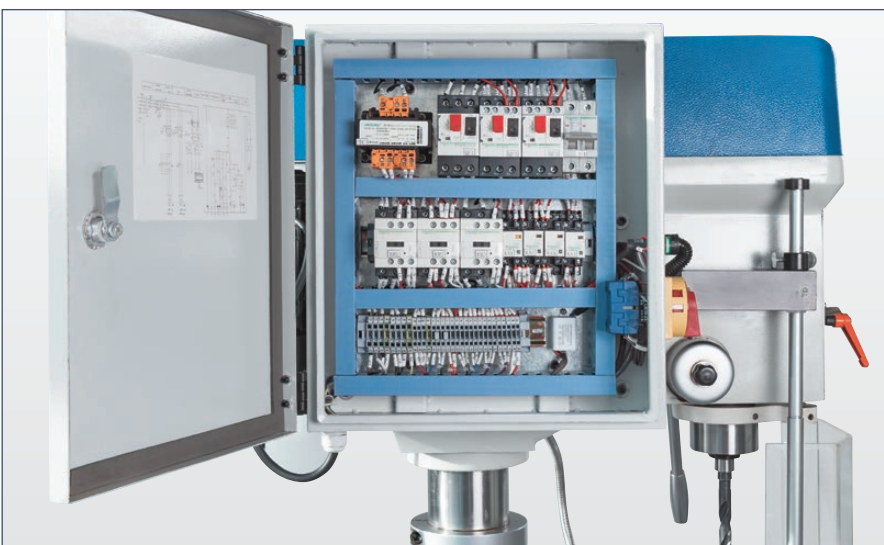

Premium components for guaranteed reliability



Large square work table with diagonal flutes

SPECIFICATIONS

Machine model numbers		KB 32 SF
Working area		
Drilling capacity	mm	32
Tapping capacity (max.)		M 24
Table set up area	mm	330x330
Spindle nose-to-table surface distance	mm	813
Spindle nose-to-foot distance	mm	1.236
Throat depth	mm	265
Column diameter	mm	100
Quill stroke	mm	150
Headstock		
Speed range	1/min	(8) 320 - 1.820
Spindle mount	MT	3
Drive capacity		
Motor rating main drive	kW	1,5
Measures and weights		
Overall dimensions (L x w x h)	m	1x0,6x2,1
Weight	kg	345
Part No.		170461



Thread cutting mode can be selected at the control panel

Column Drilling Machines

TSB Series



TSB 35 is shown with digital rpm display



Featuring gear drive, swivel drilling head and digital display for spindle speed

- Compact table design
- Swiveling drill head
- Manual transmission for high torque



INFO



VIDEO

STANDARD EQUIPMENT

- ✓ Base
- ✓ Protective shield
- ✓ Thread cutting function
- ✓ LED work lamp
- ✓ Coolant system
- ✓ Drill chuck
- ✓ Operating tools
- ✓ Operator instructions



TSB 25: compact design with manual transmission



Universal machine base with storage space included in the standard equipment



All switches and controls are clearly labeled



Swiveling drill head and automatic feed with 3 gear steps



Tapping function is included in standard equipment

SPECIFICATIONS

Machine model numbers		TSB 25	TSB 35
Working area			
Drilling capacity	mm	25	35
Tapping capacity, steel		M 16	M 22
Foot set up area (length x width)	mm	310x320	370x360
Vertical head travel	mm	470	515
Spindle nose-to-foot distance	mm	650	645
Throat depth	mm	240	320
Column diameter	mm	95	120
Headstock			
Spindle speed	1/min	(6) 125 - 2.825	(12) 125 - 3.030
Spindle mount	MK	3	4
Quill stroke	mm	110	155
Feed			
Quill feeds	mm/U	-	(3) 0,1; 0,2; 0,3
Drive capacity			
Motor rating main drive	kW	0,75	1,2
Measures and weights			
Overall dimensions (L x w x h)	m	0,7x0,41x1,56	0,81x0,5x1,67
Weight	kg	220	340
Part No.		162300	162301

Column Drilling Machines

KB 20 SV



Large square work table with diagonal flutes



Table design with infinitely variable speed adjustment and touchscreen for parameters setup

- Compact table design
- Touchscreen for selection of functions
- Integrated LED work light
- Thread cutting unit
- Infinitely variable main spindle speed



STANDARD EQUIPMENT

- | | |
|--------------------|---------------------------|
| ✓ LED work lamp | ✓ Thread cutting function |
| ✓ Drill chuck | ✓ Operating tools |
| ✓ Tool-holder bits | ✓ Operator manual |
| ✓ Drill press vise | |



AC servo motors deliver high torque at low speeds

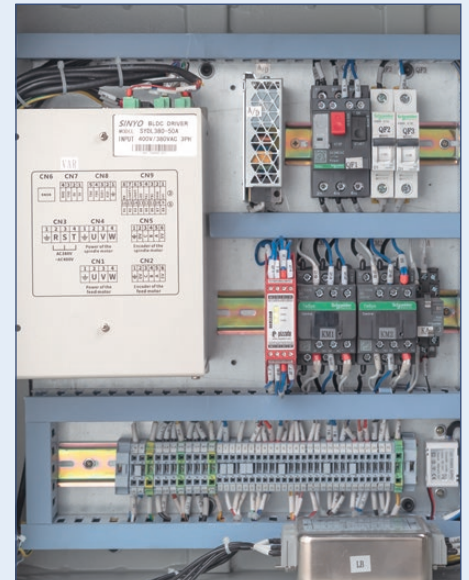

Premium components ensure high reliability and powerful performance



Large base plate with parallel clamping slots for large workpieces



Universal machine base with storage space (Part No. 123952)

SPECIFICATIONS		
Machine model numbers	KB 20 SV	
Working area		
Drilling capacity	mm	20
Tapping capacity (max.)		M 16
Table set up area	mm	255x255
Spindle nose-to-table surface distance	mm	366
Spindle nose-to-foot distance	mm	678
Throat depth	mm	240
Column diameter	mm	85
Quill stroke	mm	135
Headstock		
Speed range	1/min	205 - 2.045
Spindle mount	MT	2
Drive capacity		
Motor rating main drive	kW	1,1
Measures and weights		
Overall dimensions (L x w x h)	m	1x0,56x1,4
Weight	kg	179
Part No.		170462



Thread cutting mode can be selected at the control panel

Sawing Accessories



Roller Conveyor

Roller conveyors are an excellent addition to circular and band saws. The fed material is reliably and continuously supported. This makes material handling much easier and ensures safety. Roller conveyors are available in various lengths and in versions with length stop.



Bandsaw Blades

Our saw blades stand for highest product quality “Made in Germany”. State-of-the-art production technologies, the best materials and high process stability ensure their reproducibility.

- **“100% Made in Germany“**

All products are manufactured in Germany. The high quality is ensured during the entire production process.

- **Best input materials**

For the production of all products only such materials are used that meet strict quality guidelines.

- **State-of-the-art manufacturing technologies**

The manufacturing methods and production processes are constantly being further developed.

- **Continuous quality controls**

The high product quality is ensured by continuous quality controls.



Circular Saw Blades

Our circular saws ensure high angularity and short cutting times for rod material and profile machining. They use premium saw blades that are known for their precision, optimum teeth design and suitable blade surfaces. We also offer specific saw blades for the circular cold saws in our portfolio. This ensures cost-effective, reliable, and clean machining of cast-iron and steel.



The new KNUTH Accessory Shop is now live! → [Shop now](#)

Band and Circular Saws



Mitre Cutting Bandsaws from Page 88



Horizontal Cutting Bandsaws from Page 88



Vertical Bandsaws

Page 106



Manual Circular Saws

Page 108

Horizontal Miter Band Saws

ABS S NC Series



ABS 325 S NC



Reliable OMRON control with rugged touchscreen input panel

Double-column design, OMRON NC control with high-precision servo material feed and hydraulic bundle clamping device for series processing

- Double-column design with precise linear guidance
- Mitre cutting with hydraulic workpiece clamping and digital display
- OMRON touchscreen controller for fast programming and setup
- Material servo-feeding for high precision +/-0,2 mm
- Automated stroke height control with optical sensor

STANDARD EQUIPMENT

- | | |
|---------------------------------------|---|
| ✓ Omron control with touchscreen | ✓ Saw-band |
| ✓ Automatic workpiece feed (servo) | ✓ Mechanical saw blade tensioning with hydraulic pressure gauge |
| ✓ Hydraulic part clamping | ✓ Saw blade cleaner brush |
| ✓ Hydraulic clamping of cutting angle | ✓ Coolant system |
| ✓ Digital angle display | ✓ Operating tools |
| ✓ Optical height adjustment | ✓ Operator manual |



OPTIONAL EQUIPMENT

• Hydraulic bundle clamping for ABS S 440 NC	253898	• Hydraulic bundle clamping for ABS S 325 NC	253716
• Hydraulic saw blade tensioning for ABS S 440 NC	253823	• 3 meter roller table for ABS S 540 NC	253826
• Chip conveyor for ABS S 440 NC	253821	• Hydraulic bundle clamping for ABS S 540 NC	253717
• 3 meter roller table for ABS S 440 NC	251873	• Minimum quantity cooling for Band Saws 400 - 810	253719
• Hydraulic bundle clamping for ABS S 360 NC	253897	• Clamping force controlled at operator panel	253808
• Micro spray cooling system for Band Saws 280-380	253851	• Chip conveyor for ABS S 540 NC	253891
• 3 meter roller table for ABS S 360 NC	253825	• Hydraulic saw blade tensioning for ABS S 540 NC	253824
• Hydraulic saw blade tensioning for ABS S 360 NC	253822	• Laser pointer	253753
• Chip conveyor for ABS S 360 NC	253820		
• Hydraulic saw blade tensioning for ABS S 325 NC	253807		
• 3 meter roller table for ABS S 325 NC	253752		

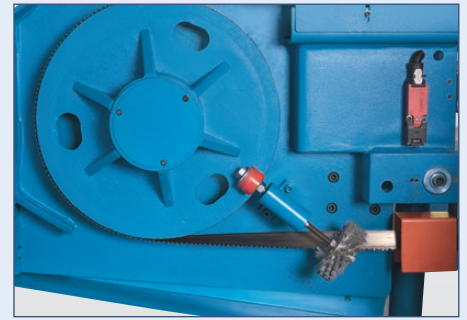

Chips around the saw blade are removed by a brush for increased efficiency and long tool life

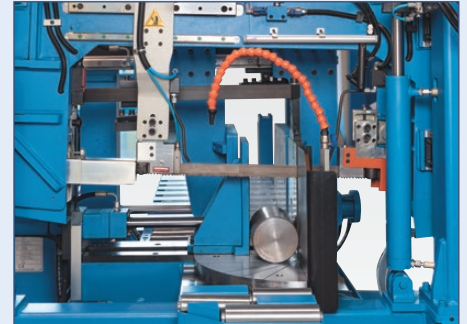

The slight drop of the saw blade is a smart design feature that increases efficiency, blade life and cut quality

SPECIFICATIONS

Machine model numbers		325	360	440	540
Working area					
Minimum cut length	mm	15	15	15	15
Remaining length	mm	275	190	190	190
Cutting Capacities					
Feed per single stroke (max.)	mm	700	700	700	700
Cutting speed	m/min	15 - 120	15 - 120	15 - 120	15 - 120
Cutting capacity 0° (round)	mm	325	360	440	540
Cutting capacity 0° (flat)	mm	400x325	610x360	610x440	690x540
Cutting capacity 0° (square)	mm	325	360	440	540
Cutting capacity 30° (round)	mm	325	360	440	540
Cutting capacity 30° (flat)	mm	360x325	530x360	540x440	550x540
Cutting capacity 30° (square)	mm	325	360	440	540
Cutting capacity 45° (round)	mm	300	360	440	470
Cutting capacity 45° (flat)	mm	260x325	400x360	440x400	410x540
Cutting capacity 45° (square)	mm	260	360	400	410
Max. feed length (multiple strokes)	mm	9.999	9.999	9.999	9.999
Accuracies					
Positioning accuracy (multiple strokes)	mm	0,2	0,2	0,2	0,2
Cutting capacity in semi-automatic mode					
Cutting capacity 60° (round)	mm	190	300	310	250
Cutting capacity 60° (flat)	mm	140x325	360x240	245x440	240x540
Cutting capacity 60° (square)	mm	140	240	245	240
Drive capacity					
Motor rating main drive	kW	2,2	3	4	4
Motor rating hydraulic pump	kW	1,5	1,1	2,2	2,2
Motor rating coolant pump	kW	0,12	0,12	0,12	0,12
Measures and weights					
Blade dimensions	mm	4.900x34x1,1	5.200x34x1,1	6.300x41x1,3	6.000x41x1,3
Overall dimensions (l x w x h)	m	2,31x2,15x1,65	2,85x2,25x1,87	3x2,25x2,05	3x2,42x2,25
Weight	kg	1.860	2.400	3.600	4.190
Part No.		152890	152841	152891	152843

Horizontal Straight Cutting Bandsaws

ABS L Serie

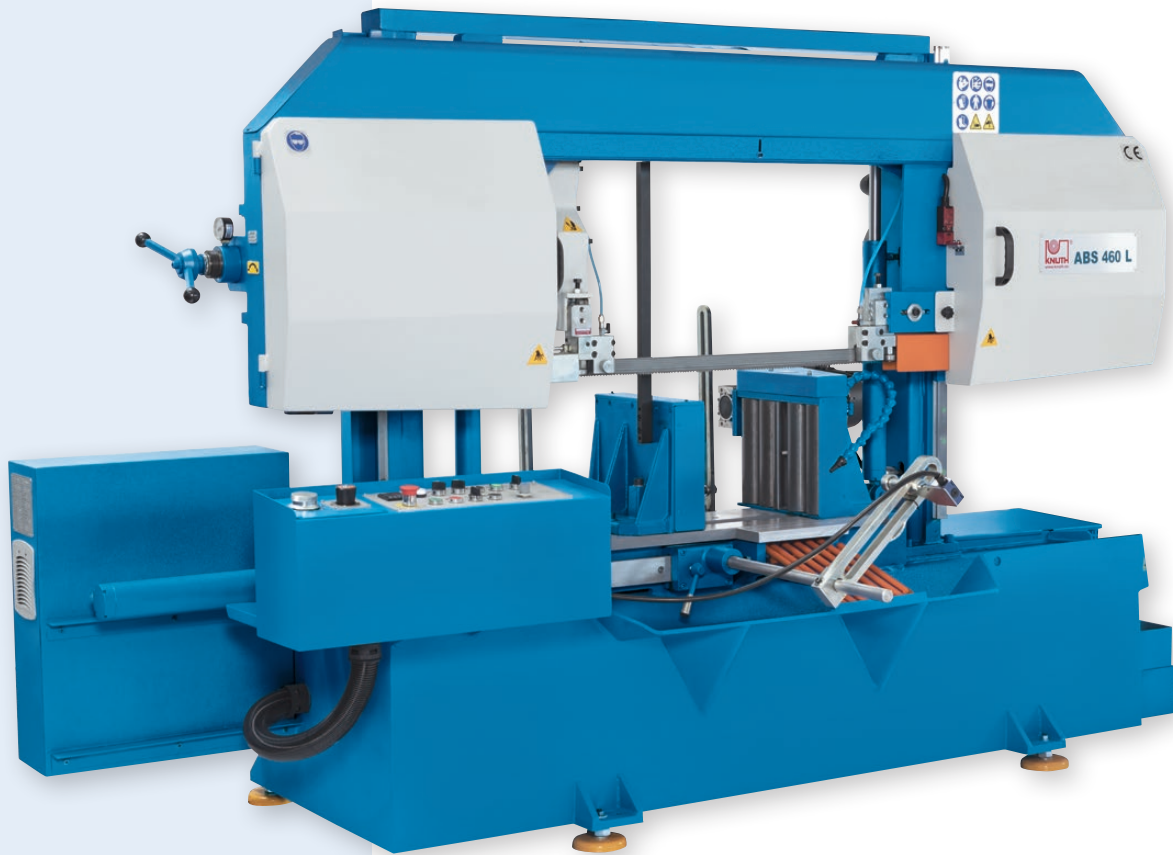

Sturdy double-column design with large cutting capacity and robust fully automatic feed for efficient series production

- Dual column design for superior stability
- Material feed system with workpiece guide rollers
- Hydraulic workpiece clamping
- Optical detection of the workpiece height
- Feed roller table 1,2 m



Pressure gauge for precise saw blade tensioning



INFO

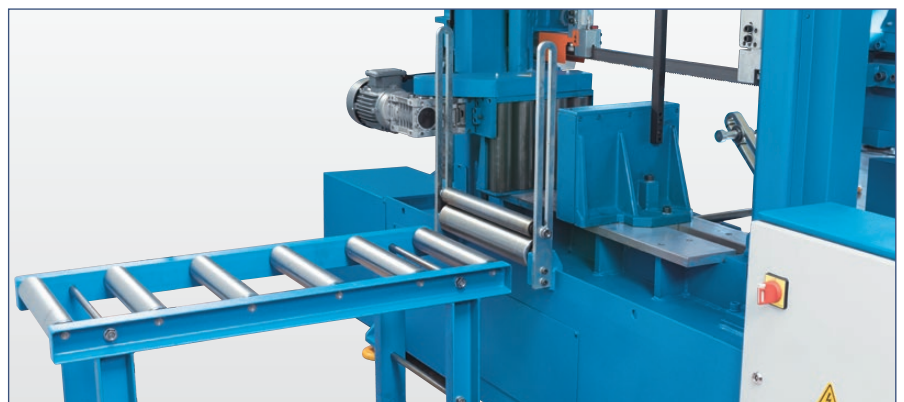

Solid feed roller table and material guide for workpiece bundles

OPTIONAL EQUIPMENT

- 3 meter roller table for ABS 330 L 253849
- 3 meter roller table for ABS 380 L 251869
- 3 meter roller table for ABS 460 L 253890
- 3 meter roller table for ABS 560 L 251877
- Chip conveyor for ABS 380 L 251870
- Chip conveyor for ABS 460 L 251874
- Chip conveyor for ABS 560 L 251878
- Hydraulic blade tentioning for ABS 380 L 251871
- Hydraulic blade tentioning for ABS 460 L 251875
- Hydraulic blade tentioning for ABS 560 L 251879
- Micro spray cooling system for Band Saws 280-380 253851
- Micro spray cooling system for band saws 400-810 254015
- Minimum quantity cooling for Band Saws 400 - 810 253719
- Laser pointer 253753
- Clamping force controlled at operator panel 253899

STANDARD EQUIPMENT

- ✓ Saw-band
- ✓ Workpiece counter
- ✓ Band break control
- ✓ Coolant system
- ✓ Hydraulic clamping
- ✓ Mechanical saw blade tensioning with hydraulic pressure gauge
- ✓ Feed roller table 1,2 m
- ✓ Linear stop
- ✓ Operator instructions

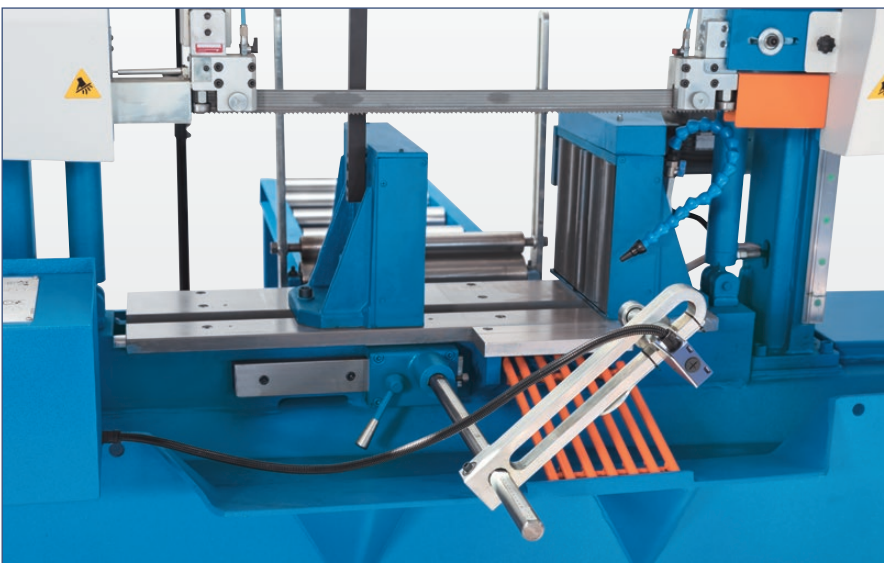

Driven feedrate rolls stop automatically when the material

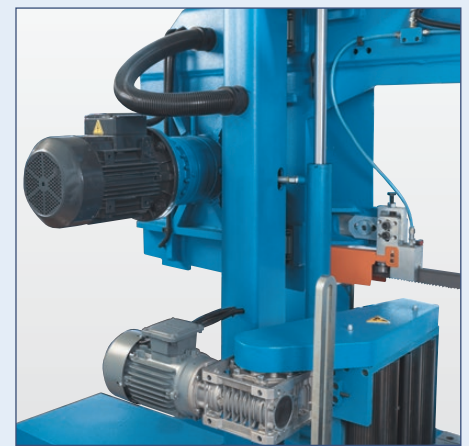

Powerful saw blade/feed motors and heavy-duty gears can handle demanding applications and high loads with quiet operation and minimal space requirement.

SPECIFICATIONS

Machine model numbers		ABS 380 L	ABS 460 L	ABS 560 L
Cutting Capacities				
Cutting capacity 0° (flat)	mm	430x380	470x460	570x560
Cutting capacity 0° (round)	mm	380	460	560
Cutting capacity 0° (square)	mm	380	460	560
Cutting speed infinitely variable	m/min	20 - 100	20 - 100	20 - 100
Stop length	mm	500	500	500
Accuracy of the feeding	mm	0,5	0,5	0,5
Drive capacity				
Motor rating main drive	kW	3	4	4
Motor rating hydraulic pump	kW	0,55	0,55	1,1
Motor rating feed	kW	0,25	0,25	0,55
Measures and weights				
Blade dimensions	mm	4.800x34x1,1	5.200x41x1,3	6.000x41x1,3
Overall dimensions (L x w x h)	m	2,9x0,95x1,66	3,1x1x1,8	3,5x1,05x2,05
Weight	kg	1.250	1.500	2.100
Part No.		152761	152766	152771

Horizontal Miter Band Saws

ABS 350 C

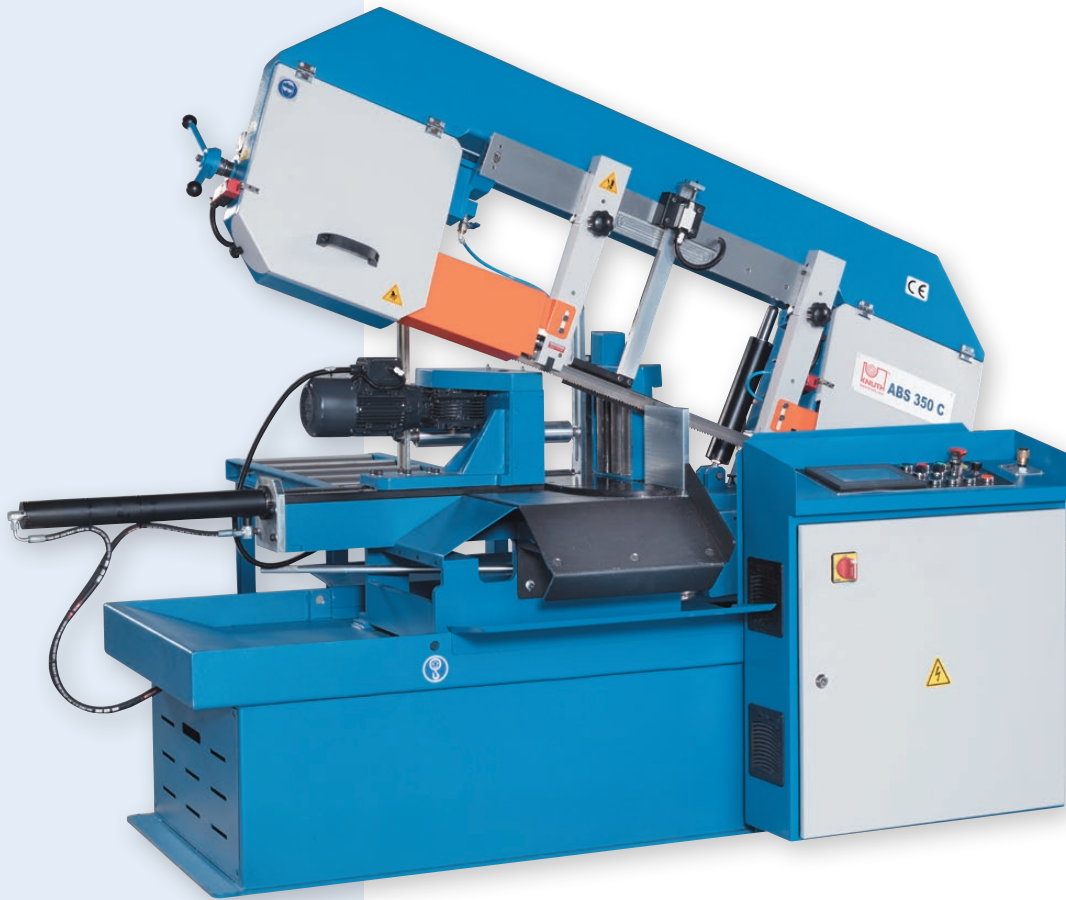

The touchscreen allows for easy and convenient programming for a fully automated operation

Fully automatic miter band saw with vice integrated feed rollers and touch screen control panel

- Vice with feed rollers
- Angle cutting possibility for increased versatility
- Facile operation via touchscreen
- Height adjustment with switch to speed up the cutting process
- Workpiece counter to facilitate continuous production
- Manual top vise for bundle cutting

STANDARD EQUIPMENT

- ✓ Automatic band break control
- ✓ Bundle vise
- ✓ Coolant system
- ✓ Hydraulic part clamping
- ✓ Saw-band
- ✓ Chip wiper
- ✓ Feed roller table 1,2 m
- ✓ Operating tools
- ✓ Operator instructions

OPTIONAL EQUIPMENT

- 3 meter roller table for ABS 350 C 253853
- Chip conveyor 253892
- Hydraulic saw blade tensioning 253895
- Micro spray cooling system for Band Saws 280-380 253851
- Laser pointer 253753
- Clamping force controlled at operator panel 253899



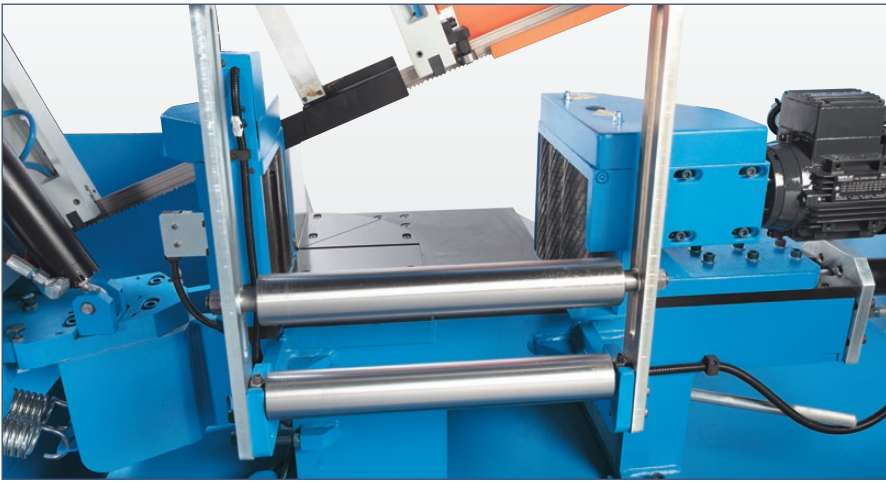

Machining of workpiece bundles possible



A feed roller table is part of the standard equipment package



The saw frame swivels up to 45° to either side



A pressure gauge is provided to ensure correct saw blade tension

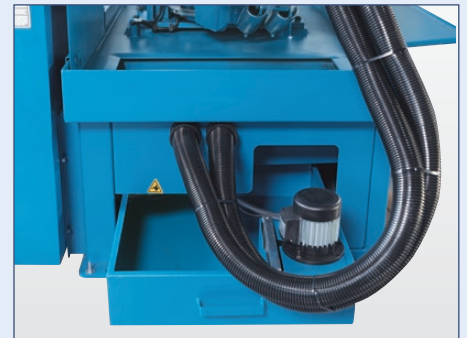

The coolant system is design highly accessible and easy to clean

SPECIFICATIONS

Machine model numbers	ABS 350 C	
Cutting Capacities		
Cutting capacity 0° (round)	mm	350
Cutting capacity 0° (flat)	mm	400x350
Cutting capacity 0° (square)	mm	350
Cutting capacity 30° (round)	mm	320
Cutting capacity 30° (flat)	mm	400x230
Cutting capacity 30° (square)	mm	350
Cutting capacity 45° (round)	mm	320
Cutting capacity 45° (flat)	mm	260x350
Cutting capacity 45° (square)	mm	280
Cutting speed	m/min	20 - 100
Drive capacity		
Motor rating main drive	kW	2,2
Motor rating hydraulic pump	kW	0,37
Motor rating coolant pump	kW	0,12
Motor rating feed	kW	0,25
Measures and weights		
Blade dimensions	mm	4.160x34x1,1
Overall dimensions (L x w x h)	m	2,45x0,92x2,02
Weight	kg	1.050
Part No.		152758

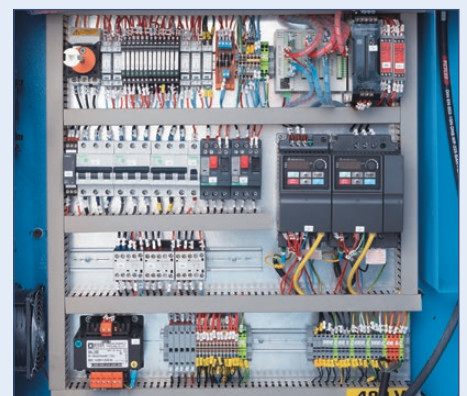

Premium components for guaranteed long-lasting reliable operation

Horizontal Straight Cutting Bandsaws

ABS 320 PLC



PLC control with touchscreen

Fully automatic band saw with motorized material feed

- Touchscreen for automatic feed
- Hydraulic workpiece clamping
- Bundling vise
- Infinitely variable cutting speeds

STANDARD EQUIPMENT

- ✓ PLC-control with touch-screen
- ✓ Hydraulic part clamping
- ✓ Bundle vise
- ✓ Mechanical saw blade tensioning with hydraulic pressure gauge
- ✓ Optical height adjustment
- ✓ Automatic band break control
- ✓ Feed roller table 1,2 m
- ✓ Coolant system
- ✓ Saw-band
- ✓ Saw blade cleaner brush
- ✓ Operating tools
- ✓ Operator instructions

OPTIONAL EQUIPMENT

- 3 meter roller table 251888
- Chip conveyor 251889
- Hydraulic saw blade tensioning 253894
- Micro spray cooling system for Band Saws 280-380 253851
- Laser pointer 253753



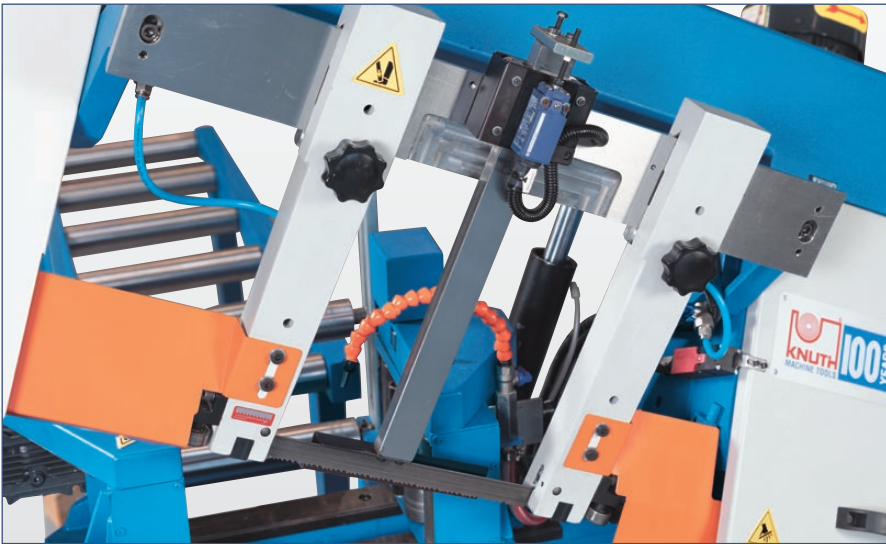

Automatic limiting of saw frame stroke after the cut reduces down times



A motor with infinitely variable speeds transmits power via a continuous-operation idler gear to the machine drive wheel



Hydraulic part clamping included in standard equipment



Pressure gauge simplifies precise adjustment of saw blade tension

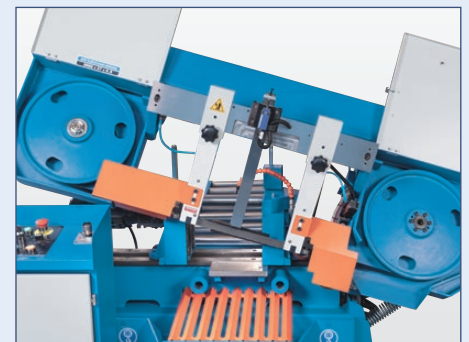

Long saw blade and large idlers for extended tool life

SPECIFICATIONS

Machine model numbers		ABS 320 PLC
Cutting Capacities		
Cutting capacity 0° (round)	mm	320
Cutting capacity 0° (square)	mm	320
Cutting capacity 0° (flat)	mm	320x320
Cutting speed	m/min	15 - 120
Working height	mm	640
Drive capacity		
Motor rating main drive	kW	2,2
Motor rating hydraulic pump	kW	0,37
Motor rating coolant pump	kW	0,12
Motor rating feed	kW	0,25
Measures and weights		
Blade dimensions	mm	3.660x27x0,9
Overall dimensions (L x w x h)	m	1,9x0,85x1,3
Weight	kg	770
Part No.		152759

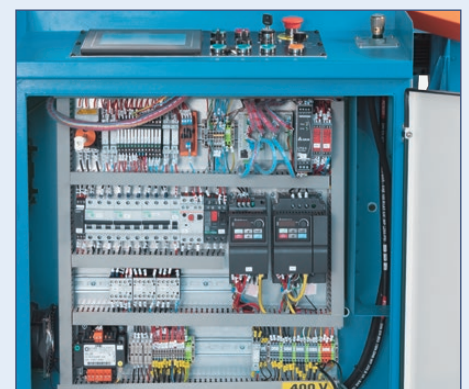

The control cabinet is set up ergonomically and meets all safety standards and regulations

Horizontal Miter Band Saws HB L Series

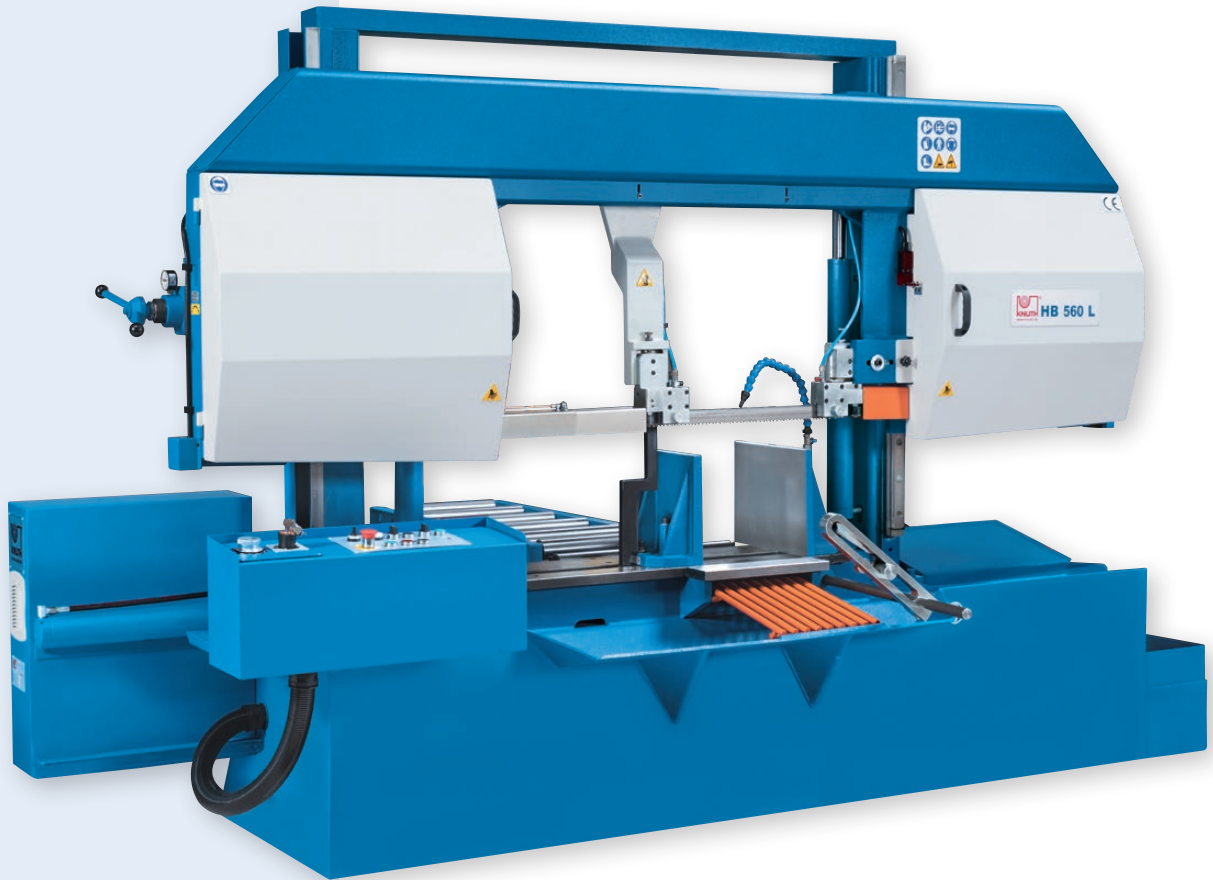

Stable double column construction with linear guide for large diameters with hydraulically clamping and swivelling vise

- Double column design with linear guide
- Semi-automatic operation
- Automatic stroke height adjustment with optical sensor
- 45° swiveling vise for miter cutting
- Short setup time for machine and workpiece



Removable coolant reservoir for simplified maintenance

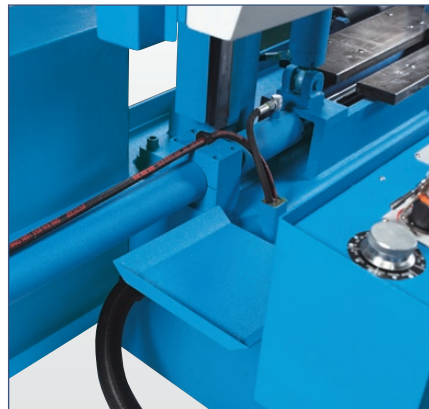

Hydraulic workpiece clamping is now included on all models

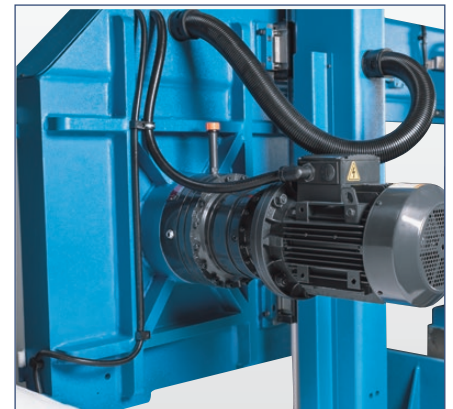

Powerful main drive motor, infinitely variable



OPTIONAL EQUIPMENT

• 6 m Roller table w. length stopper & digital readout for HB 380L	257416	• Motorized 3 meter roller table for HB 380 L	251595
• 3 m Roller table w. length stopper & digital readout for HB 380L	257415	• 3 meter roller table for HB 380 L	251594
• Micro spray cooling system for Band Saws 280-380	253851	• Hydraulic top clamping for HB 380 L	251592
• Hydraulic blade tensioning for HB 380 L	251600	• Minimum quantity cooling for Band Saws 400 - 810	253719
• Turn Table for HB 380 L	251599	• Laser pointer	253753
• Chip conveyor for HB 380 L	251596	• Clamping force controlled at operator panel	253899

STANDARD EQUIPMENT

- ✓ Feed roller table 1 m
- ✓ Bimetallic band saw blade
- ✓ Hydraulic part clamping
- ✓ Automatic stroke high adjustment
- ✓ PAS system
- ✓ Coolant system
- ✓ Operator instructions

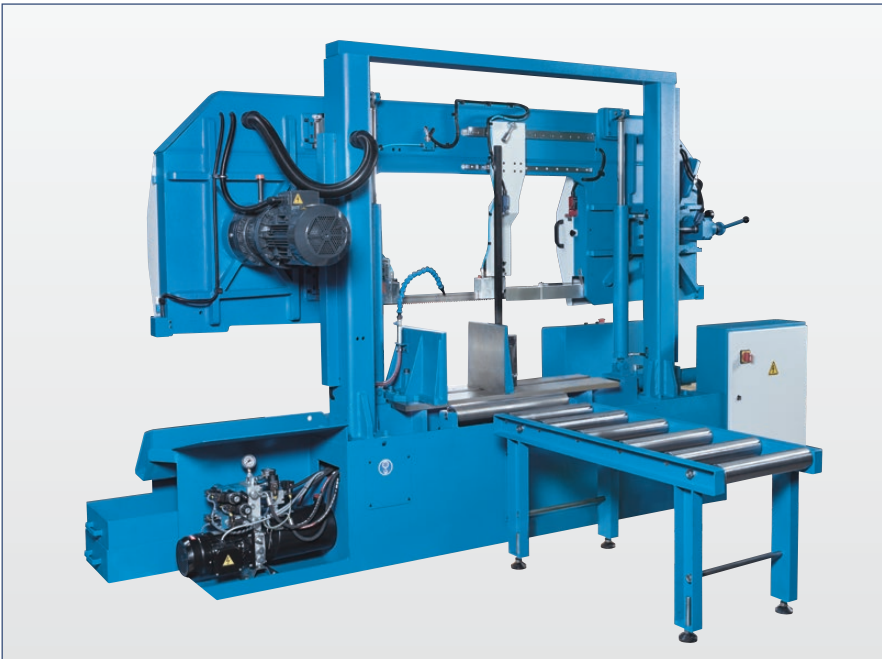

Feed roller table is standard equipment



Pressure gauge ensures correct saw blade tension for increased blade life and cost reduction

SPECIFICATIONS

Machine model numbers		380 L	460 L	560 L	810 L
Cutting Capacities					
Cutting capacity 0° (round)	mm	380	460	560	810
Cutting capacity 0° (square)	mm	380	460	560	810
Cutting capacity 0° (flat)	mm	520x380	650x460	750x550	790x850
Cutting capacity 45° (round)	mm	300	380	410	480
Cutting capacity 45° (square)	mm	300	380	410	810
Cutting capacity 45° (flat)	mm	300x380	380x460	410x550	480x790
Cutting speed	m/min	20 - 100	20 - 100	20 - 100	15 - 120
Drive capacity					
Motor rating main drive	kW	3	4	4	5,5
Motor rating hydraulic pump	kW	0,55	0,55	1,1	1,5
Motor rating coolant pump	kW	0,12	0,12	0,12	0,12
Measures and weights					
Blade dimensions	mm	5.200x34x1,1	5.200x41x1,3	6.000x41x1,3	8.200x41x1,3
Overall dimensions (l x w x h)	m	2,85x1,69x1,05	3,1x1,8x1,05	3,4x1,15x2,25	3,9x1,4x2,72
Weight	kg	1.150	1.410	1.750	3.050
Part No.		152767	152806	152811	152816

Horizontal Miter Band Saws

HB 320 BS

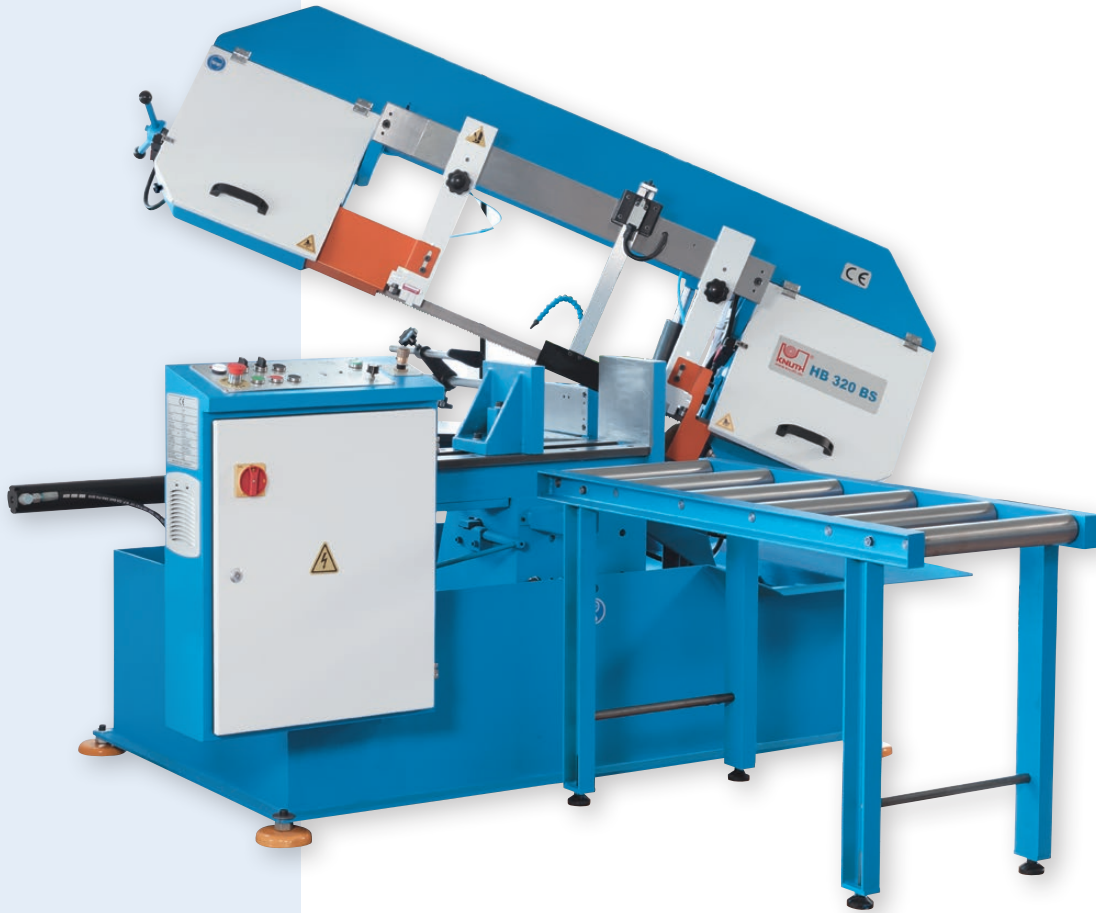

Miter bandsaw with swivel frame and hydraulic machine vise

- Saw frame can swivel 60° for miter cutting
- Semi-automated operation
- Automated stroke height control with optical sensor
- Low machine and workpiece setup times



The cutting angle is precisely adjustable and can be easily read

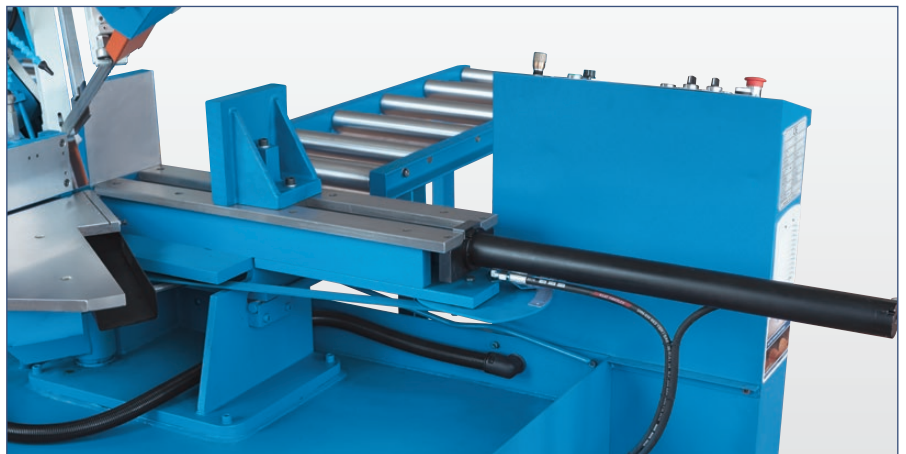

Hydraulic part clamping with wide clamping range



INFO

OPTIONAL EQUIPMENT

• 3 meter roller table	251893	• 6m Roller table w. length stopper & digital readout	257414
• hydraulic top clamping for HB 320 BS	251891	• Micro spray cooling system for Band Saws 280-380	253851
• Motorized 3 meter roller table	251894	• Laser pointer	253753
• Hydraulic blade tentioning	251895	• Clamping force controlled at operator panel	253899
• 3m Roller table w. length stopper & digital readout	257413		

STANDARD EQUIPMENT

- ✓ Hydraulic part clamping
- ✓ Coolant system
- ✓ Linear stop
- ✓ Feed roller table 1,2 m
- ✓ Operator manual



Rigid feed roller tables simplify material handling

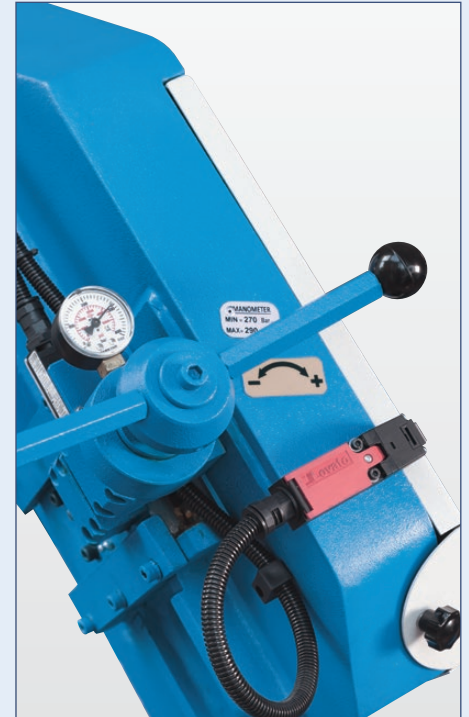

High-precision adjustment of saw blade tension

SPECIFICATIONS

Machine model numbers		HB 320 BS
Cutting Capacities		
Cutting capacity 0° (round)	mm	320
Cutting capacity 0° (square)	mm	320
Cutting capacity 0° (flat)	mm	610x320
Cutting capacity 30° (round)	mm	320
Cutting capacity 45° (square)	mm	320
Cutting capacity 45° (flat)	mm	355x320
Cutting capacity 60° (round)	mm	250
Cutting capacity 60° (square)	mm	210
Cutting capacity 60° (flat)	mm	320x170
Cutting speed infinitely variable	m/min	15 - 120
Drive capacity		
Motor rating main drive	kW	2,2
Motor rating coolant pump	kW	0,12
Measures and weights		
Blade dimensions	mm	4.160x34x1,1
Overall dimensions (L x w x h)	m	2,1x1,2x1,35
Weight	kg	1.195
Part No.		152798

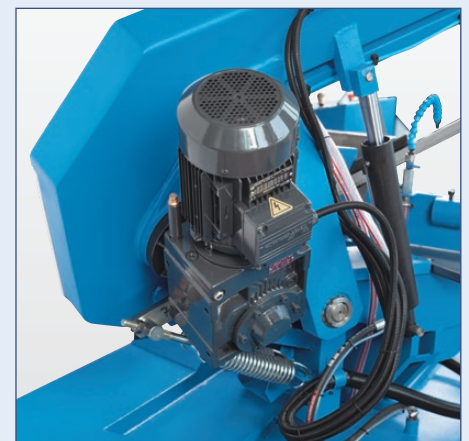

The compact drive unit delivers high torque

Horizontal Miter Band Saws

SBS Series



SBS 355 is shown



Saw frame with hydraulic or manual feed

Double miter bandsaw with great cutting performance in the best processing quality and with an outstanding price-performance ratio

- One-piece cast-iron saw frame
- Rigid vise with long stroke
- High cutting capacity
- Compact design
- Quick-action angle adjustment left and right

STANDARD EQUIPMENT

- ✓ 1 saw blade
- ✓ Coolant system
- ✓ Base
- ✓ Pressure gauge for saw blade tensioning
- ✓ Hydraulic cylinder for saw frame
- ✓ Inverter for infinitely variable saw blade speed
- ✓ Hydraulic workpiece clamping
- ✓ Operator instructions



INFO



Adjustable rigid guideways ensure precise cuts



A pressure gauge is provided to ensure precise saw blade tensioning

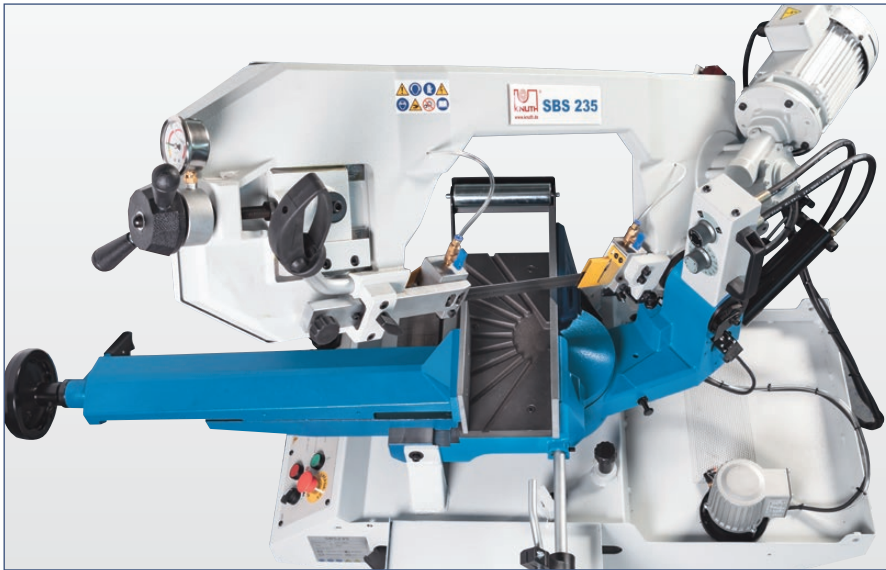

Large swivel range for right and left miter cuts



The manual vise on the SBS 235/255 features a quick-action clamping function

SPECIFICATIONS

Machine model numbers		SBS 235	SBS 255 N	SBS 355
Cutting Capacities				
Cutting capacity 0° (round)	mm	225	255	355
Cutting capacity 0° (square)	mm	180	255	300
Cutting capacity 0° (flat)	mm	150x245	315x160	300x490
Cutting capacity 45° L (square)	mm	145	180	250
Cutting capacity 45° L (flat)	mm	145x190	140x220	250x250
Cutting capacity 45° L (round)	mm	145	180	290
Cutting capacity 45° R (square)	mm	120	170	290
Cutting capacity 45° R (round)	mm	120	195	350
Cutting capacity 45° R (flat)	mm	120x120	140x220	290x340
Cutting capacity 60° R (round)	mm	90	115	230
Cutting capacity 60° R (square)	mm	90	115	180
Cutting capacity 60° R (flat)	mm	90x115	115x160	180x220
Cutting speed	m/min	45 / 90	35 / 70	20 - 80 (infinitely var.)
Drive capacity				
Motor rating main drive	kW	1,1	1,5	2,2
Measures and weights				
Saw blade dimensions	mm	2.645x27x0,9	2.750x27x0,9	3.770x34x1,1
Overall dimensions (l x w x h)	m	1,46x0,73x1,06	1,73x0,73x1,1	2,18x0,96x1,6
Weight	kg	295	380	805
Part No.		152778	152781	152788

Horizontal Miter Band Saws

HB 250 A



All functions are accessible on a compact control panel

Affordable workshop bandsaw with quick action clamping and miter cutting

- Cast-iron saw frame, one-piece construction
- Two speeds for cutting optimization
- Vise with quick-action clamping feature

STANDARD EQUIPMENT

- ✓ 1 saw blade
- ✓ Coolant system
- ✓ Base
- ✓ Quick-action vise
- ✓ Hydraulic cylinder for saw frame
- ✓ Operator instructions

OPTIONAL EQUIPMENT

- Bi-metal band saw blade, 2080x20x0.9 mm, 4/6 teeth 119925
- Bi-metal band saw blade, 2080x20x0.9 mm, 10/14 teeth 119739
- Bi-metal band saw blade, 2080x20x0.9 mm, 5/8 teeth 119737



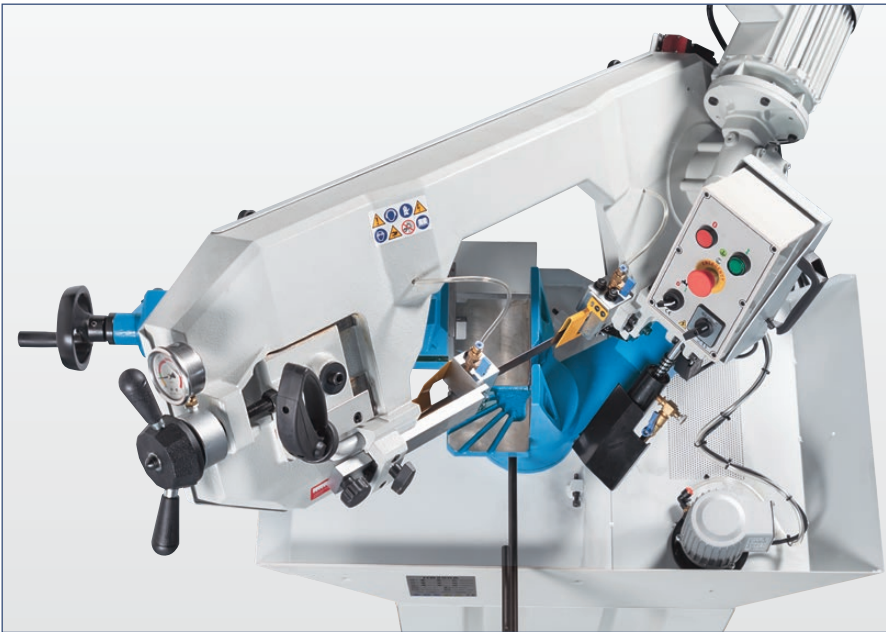

Saw frame swivels up to 60°



The scale ensures exact angle positioning

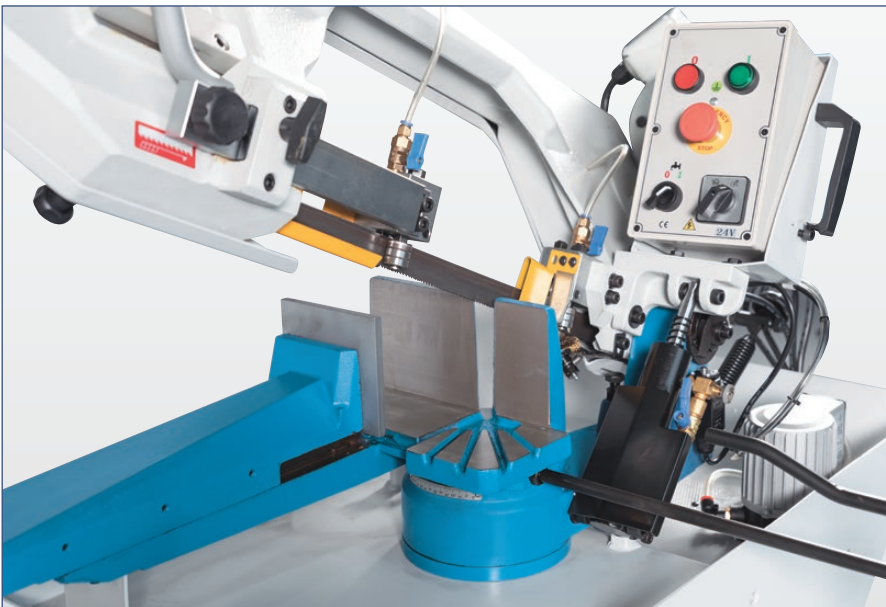

Hydraulic cylinder for infinitely variable saw frame feed



Manually adjustable stop for batch cutting

SPECIFICATIONS

Machine model numbers	HB 250 A	
Cutting Capacities		
Cutting capacity 0° (round)	mm	225
Cutting capacity 0° (flat)	mm	245x150
Cutting capacity 45° (flat)	mm	190x150
Cutting capacity 45° (round)	mm	145
Cutting capacity 60° - round	mm	90
Belt speed	m/min	40 / 90
Drive capacity		
Main motor rating	kW	1,1
Measures and weights		
Overall dimensions (L x w x h)	m	1,36x0,58x0,9
Weight	kg	185
Part No.	152796	



Pressure gauge for precise saw blade tensioning

Horizontal Miter Band Saws

B 200 S



High cutting capacity and angle cuts up to 45°



Coolant system is included



Economical mobile bandsaw for workshop use with swiveling vise for miter cuts

- One-piece cast-iron saw frame
- 45° swiveling vise for miter cutting
- Compact design
- Hydraulic cylinder-adjustable saw frame feed
- Coolant unit in machine base

STANDARD EQUIPMENT

- ✓ Coolant system
- ✓ Quick-action vise
- ✓ Mobile base
- ✓ Saw-band
- ✓ Operator instructions

OPTIONAL EQUIPMENT

- Bi-metal band saw blade, 2360x20x0.9 mm, 5/8 teeth 119774
- Bi-metal band saw blade, 2360x20x0.9 mm, 10/14 teeth 119775
- Bi-metal band saw blade, 2360x20x0.9 mm, 4/6 teeth 119150

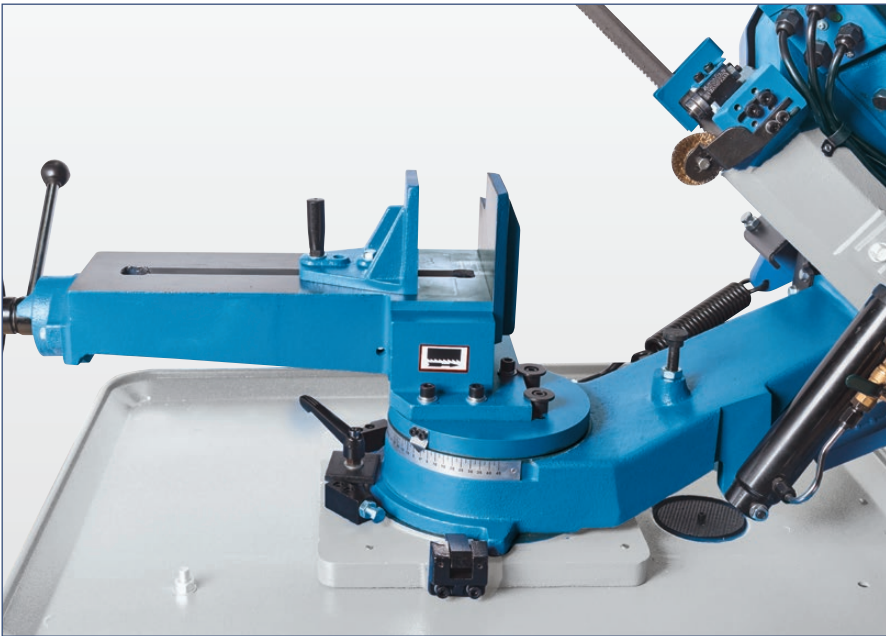

Minimum downtime: allows precise adjustment of angular stops, including quick-action clamps at the vise



The vise features a large clamping width

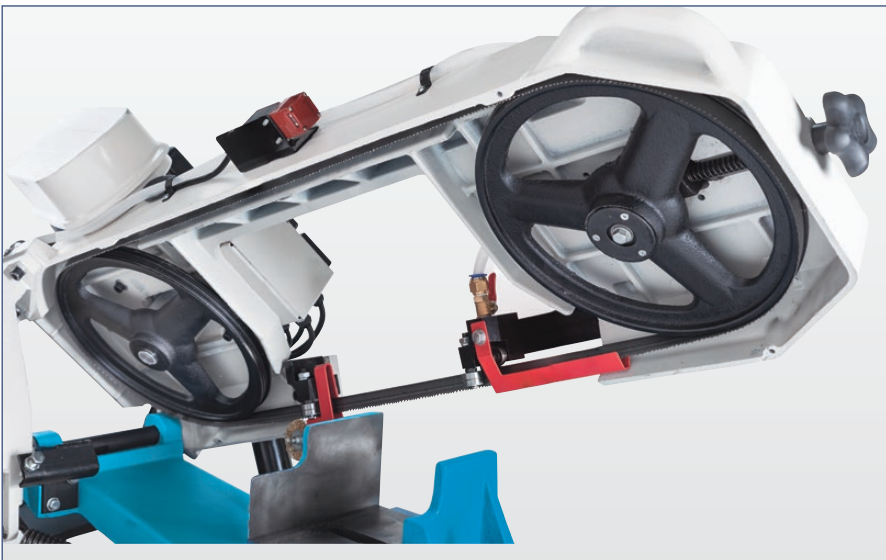

Large idlers ensure increased saw blade life and cutting capacity

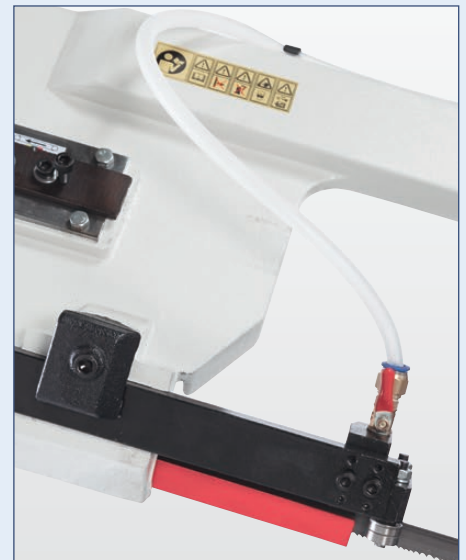

Stable, adjustable saw blade guide

SPECIFICATIONS		
Machine model numbers		B 200 S
Cutting Capacities		
Cutting capacity 0° (round)	mm	205
Cutting capacity 0° (square)	mm	205
Cutting capacity 0° (flat)	mm	205x215
Cutting capacity 45° L (round)	mm	143
Cutting capacity 45° L (flat)	mm	143x115
Belt speed	m/min	24 / 41 / 61 / 82
Drive capacity		
Motor rating main drive	kW	1,1
Measures and weights		
Blade dimensions	mm	2.360x20x0,9
Overall dimensions (L x w x h)	m	1,23x0,65x1,32
Weight	kg	190
Part No.		102752



Powerful AC motor with durable and low-maintenance V-belt drive

Vertical Band Saws

VB-A Series



VB 300 A

The solution for contour sawing with a particularly stable saw frame, table that can be swivelled on both sides, minimum quantity cooling and strip welding unit

- Swiveling table
- Infinitely variable belt speed
- Adjustable saw blade guide with carbide jaws
- Saw blade welder with shearing and grinding unit



Minimalmengen-Kühleinrichtung erhöht die Standzeit des Sägeblattes



INFO

STANDARD EQUIPMENT

- ✓ Saw blade welder assembly,
- ✓ Blade cutting unit
- ✓ Work lamp
- ✓ Saw-band
- ✓ Coolant system
- ✓ Adjustable material stop for table
- ✓ Operator instructions

OPTIONAL EQUIPMENT

- Bi-metal band saw blade, 4500x13x0.65 mm, 6/10 teeth 119245
- Coolant Concentrate 5 Ltr. 103184



Sägeblattschweißapparat mit Ausglühvorrichtung, Sägeblattschere und Schleifstein zum Trennen und Zusammenfügen des Sägeblattes bei der Bearbeitung geschlossener Innenkonturen



Die besonders stabile Führung des Umlenkrades garantiert dessen dauerhaft präzise Ausrichtung und steigert damit die Schneidleistung und Standzeit der Bandsägeblätter

SPECIFICATIONS

Machine model numbers		300 A	500 A	585 A
Working area				
Table dimensions	mm	500x400x890	700x660x980	700x660x1.002
Table with angle adjustment (l/r)	deg	15/45	15/30	15/30
Cutting Capacities				
Cutting capacity height x throat depth	mm	185x310	310x500	336x585
Cutting speed	m/min	10 - 180	15 - 328	15 - 328
Drive capacity				
Motor rating main drive	kW	0,55	1,5	1,5
Motor rating grinding	kW	0,09	0,09	0,09
Blade welder capacity	kVA	2,4	2,4	2,4
Measures and weights				
Blade width	mm	3 - 16	3 - 16	6 - 19
Overall dimensions (L x w x h)	m	0,91x0,82x1,6	1,25x1,04x1,98	1,33x1,06x2,11
Weight	kg	275	410	555
Part No.		102640	102642	102643

Circular Sawing Machines

KKS T Series



Rigid machine base with small footprint

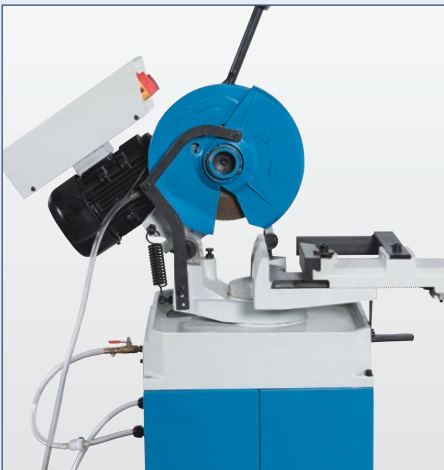

Integrated coolant system



INFO



Robust manual cold circular saw for workshop use with precise mitre adjustment and space-saving base frame

- High-precision angle cuts
- Rigid vise
- Rigid machine base included
- Built-in coolant system

STANDARD EQUIPMENT

- ✓ Self centering double vice
- ✓ Base
- ✓ Coolant system
- ✓ 1 saw blade

OPTIONAL EQUIPMENT

- Circular Saw Blade 350x3.0x40mm, ZT 5 109809
- Discharge roller track, 1000 mm 170363
- Discharge roller track, 2000 mm 170364
- Discharge roller track, 3000 mm 170365
- Feed roller track, 1000 mm 170360
- Feed roller track, 2000 mm 170361
- Feed roller track, 3000 mm 170362
- Coolant Concentrate 5 Ltr. 103184

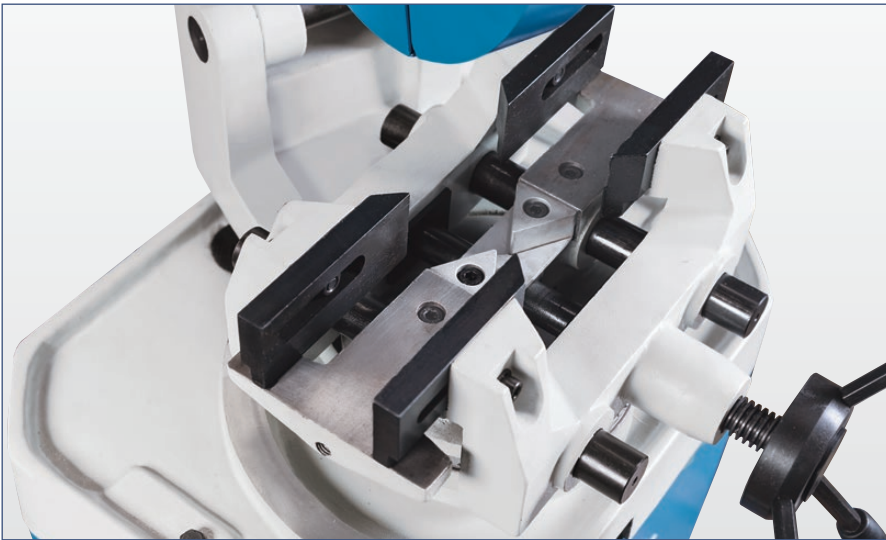

Dual vise (KKS 350 T)

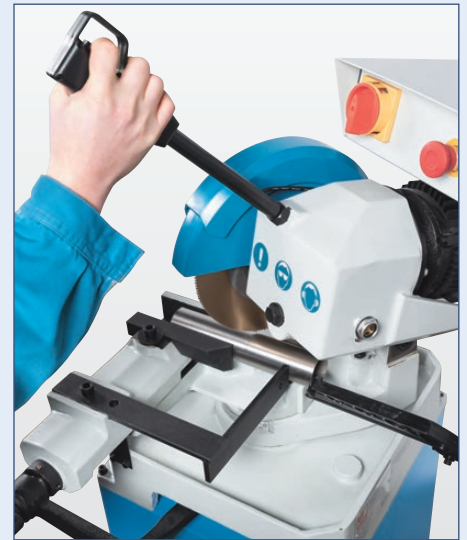

Precise miter adjustment up to +/- 45 deg.



High cutting capacity during mitering



Rigid workpiece clamping with additional fixation of the section

SPECIFICATIONS

Machine model numbers		KKS 275 T	KKS 350 T
Working area			
Max. saw blade diameter	mm	275	350
Shaft diameter	mm	32	32
Speed	1/min	42	18/36
Width of vise	mm	100	145
Working height	mm	960	960
Cutting Capacities			
Cutting capacity 0° (round)	mm	70	120
Cutting capacity 0° (square)	mm	65	110
Cutting capacity 0° (flat)	mm	90x45	140x100
Cutting capacity 45° L (round)	mm	65	105
Cutting capacity 45° L (square)	mm	60	100
Cutting capacity 45° L (flat)	mm	70x45	100x100
Cutting capacity 45° R (round)	mm	65	105
Cutting capacity 45° R (square)	mm	60	100
Cutting capacity 45° R (flat)	mm	70x45	100x100
Drive capacity			
Main motor rating	kW	1,1	0,75 / 1,3
Measures and weights			
Overall dimensions (L x w x h)	m	0,92x0,48x1,78	0,97x0,56x1,83
Weight	kg	148	236
Part No.		102118	102121

Grinding Accessories



Abrasives

With a grinding process, a relatively fine processing of the surface is usually carried out. There are now a large number of different grinding machines. Conventional and NC or CNC-controlled cylindrical and bottle grinding machines usually require an appropriate grindstone to process the workpiece. Tool grinding machines, as well as belt and disc grinding machines, can also be equipped with a sanding belt or sandpaper, depending on the design.



Sanding Belts

Belt sanders use endless sanding belts that are threaded around a drive roll and an idler roll. These belts consist of cross-bonded abrasives strips on a textile base. The grit specifications corresponds to the grit of sanding paper. For most of our machines we offer sanding belts with a typical grit between 80 and 400.



Grinding Wheels & Discs

Grinding wheels are made of abrasive hard minerals and suitable bonding materials. The most widely used grinding wheel materials are synthetic abrasives, like corundum (Al₂O₃), silicon carbide (SiC), cubic boron nitride (CBN), or synthetic diamonds. The self-adhering disk sanders in this category are comparable to the sanding belts we offer for our belt grits. (See Sanding Belts)



The new KNUTH Accessory Shop is now live! → [Shop now](#)



Grinding Machines



Conventional Cylindrical Grinders

from Page 112



NC Surface Grinders

from Page 120



Tool Grinders

Page 118/119

Servogrind® RSM NC Series

The touchscreen allows for easy programming of individual grinding cycles



Servo-conventional cylindrical grinding with NC-controlled cycles for internal and external machining

- NC control with touchscreen
- Grinding cycles for internal and external cylindrical grinding
- Servomotors in both axes
- Swivelling table and swivelling work spindle
- Extensive range of standard accessories

STANDARD EQUIPMENT

- | | |
|---|---------------------------------|
| ✓ NC control with touchscreen | ✓ Open and closed rest |
| ✓ Electronic handwheel Y-, Z-axis | ✓ Coolant device |
| ✓ Internal grinding device | ✓ Automatic central lubrication |
| ✓ Workspace protection | ✓ Accessories for grinding |
| ✓ Pneumatic tailstock quill | ✓ LED work light |
| ✓ 3-Jaw chuck Ø 200 mm | ✓ Operator instructions |
| ✓ Grinding wheel dresser | |
| ✓ Balancing mandrel and balancing stand | |

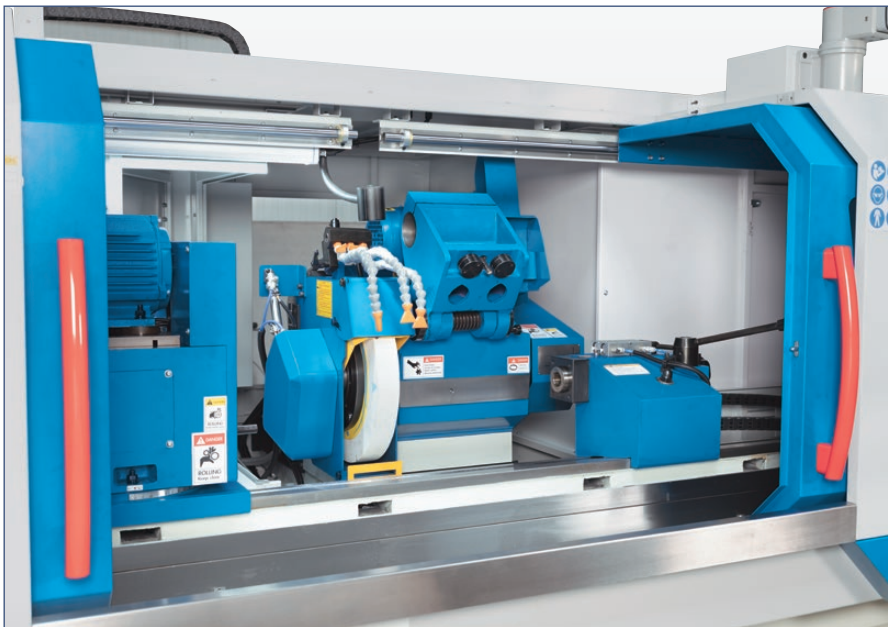

Wide-opening doors allow for easy access to the fully enclosed working area



The internal grinding device can be swivelled into the working area

SPECIFICATIONS

Machine model numbers		600 NC	1000 NC	1500 NC
Working area				
Center height	mm	180	180	180
Grinding diameter	mm	8 - 320	8 - 320	8 - 320
Grinding diameter with steady rest	mm	15 - 150	15 - 150	15 - 150
Grinding length	mm	600	1.000	1.500
Inside grinding diameter with rest	mm	35 - 100	35 - 100	35 - 100
Inside grinding diameter without rest	mm	30 - 100	30 - 100	30 - 100
Inside grinding depth	mm	125	125	125
Workpiece weight between centers (max.)	kg	100	150	150
Table swivel range (max.)		-2° / +9°	-2° / +9°	-2° / +9°
Wheel speeds	m/s	45	45	45
Travels				
Grinding head travel	mm	195	250	250
Headstock				
Working headstock swivel range	deg	90	90	90
Working spindle taper	MK	4	4	4
Chuck diameter	mm	200	200	200
Work spindle speeds	1/min	25 - 500	25 - 500	25 - 500
Grinding headstock				
Grinding spindle speed	1/min	2.140	2.140	2.140
Grinding headstock swivel range (r+l)		10°	10°	10°
Inside grinding spindle speed	1/min	10.000	10.000	10.000
Tailstock				
Tailstock taper	MK	4	4	4
Tailstock quill stroke	mm	30	30	30
Drive capacity				
Motor rating - grinding spindle	kW	4	4	4
Motor rating inside grinding	kW	1,1	1,1	1,1
Motor rating - headstock / coolant pump	kW	0,75 / 0,13	1,5 / 0,13	1,5 / 0,13
Measures and weights				
Grinding wheel dimensions	mm	400x50x203	400x50x203	400x50x203
Grindstone dimensions, inside grinding (max.)	mm	40x25x13	32x25x10	50x40x16
Overall dimensions (l x w x h)	m	3,03x2,3x2	4,1x2,2x1,8	5,1x2,2x1,8
Weight	kg	2.800	3.300	3.700
Part No.		124959	124960	124961

Conventional Cylindrical Grinding Machines

RSM C Series

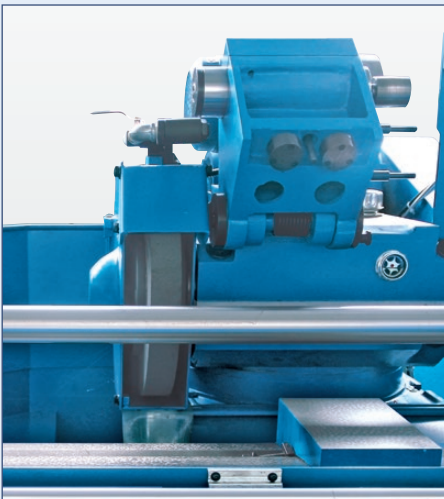
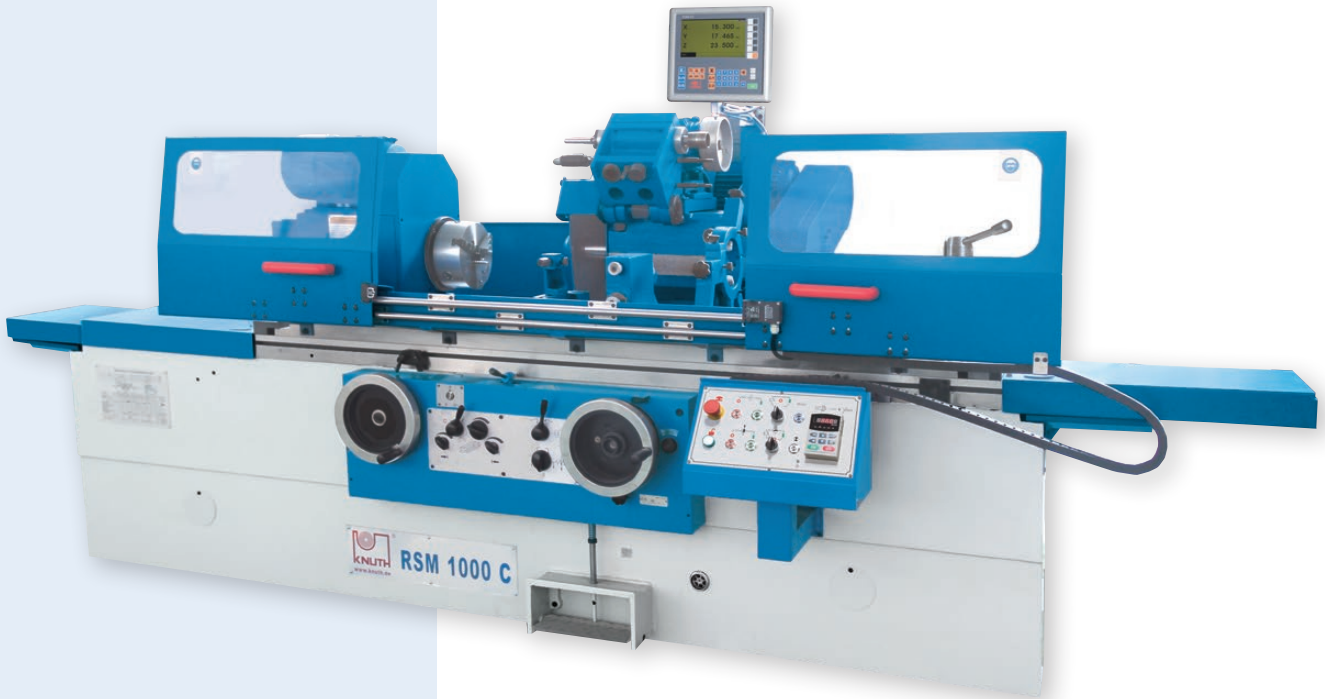

Maximum precision and surface quality

Inside and outside machining with auto feed on transverse axis

- Internal and external grinding
- Hydrostatic bearings for high surface quality
- Heavy machine frame to support large workpieces
- Swiveling headstock for conical grinding of short parts
- Integrated rapid feed on Z-axis with manual return
- Extensive package of standard accessories

STANDARD EQUIPMENT

- | | |
|---------------------------------------|---------------------------------|
| ✓ 2-axis position indicator X.Pos 3.2 | ✓ Balancing mandrel |
| ✓ Internal grinding equipment | ✓ Grinding wheel flange |
| ✓ Open rest | ✓ Center point |
| ✓ Closed rest | ✓ Front and rear splatter guard |
| ✓ 3-jaw chuck Ø 200 mm | ✓ Drivers |
| ✓ Coolant system | ✓ Operating tools |
| ✓ Grinding wheel dresser | ✓ Operator manual |
| ✓ Balancing station | |



INFO



VIDEO

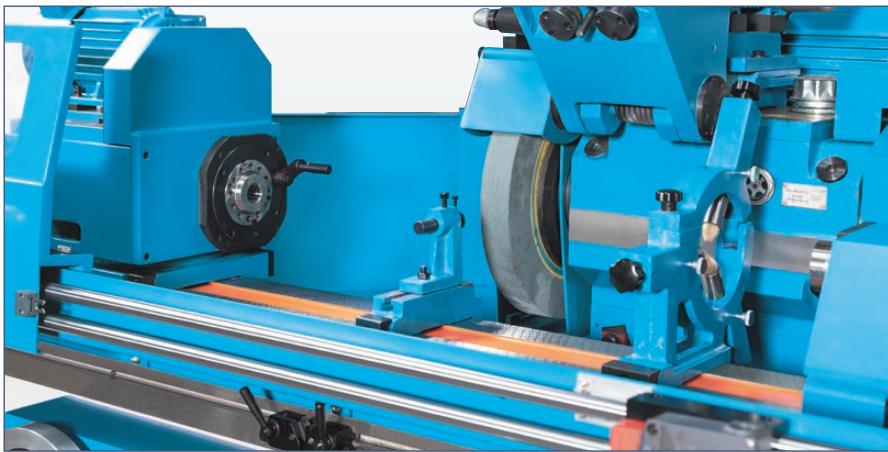

Long workpieces are guided in rests

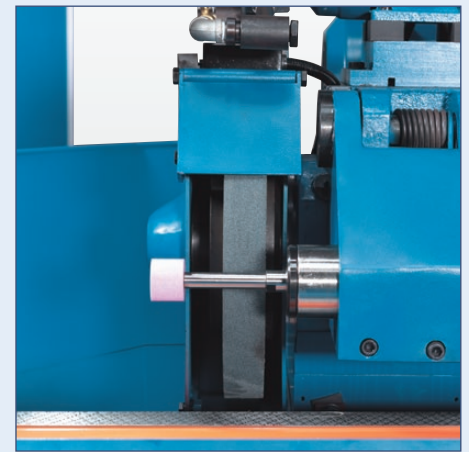

Inside grinder for grinding parts with diameters up to 100 mm is included

SPECIFICATIONS

Machine model numbers		750 C	1000 C	1500 C
Working area				
Center height	mm	135	180	180
Grinding diameter	mm	8 - 200	8 - 320	8 - 320
Grinding diameter with steady rest	mm	8 - 60	60	60
Grinding length	mm	750	1.000	1.500
Inside grinding diameter with rest	mm	35 - 100	35 - 100	35 - 100
Inside grinding diameter without rest	mm	25 - 100	30 - 100	30 - 100
Inside grinding depth	mm	125	125	125
Workpiece weight between centers (max.)	kg	80	150	150
Grinding wheel feed (min.)	mm	0,0025	0,0025	0,0025
Chuck diameter	mm	200	200	200
Table swivel range (max.)		-2° / +6°	-3° / +7°	-3° / +6°
Wheel speeds	m/s	35	35	35
Work spindle speeds	1/min	50 Hz: 25-380	50 Hz: 25-220	50 Hz: 25-220
Travels				
Grinding head travel	mm	200	250	250
Feed				
Table feed, infinitely variable	m/min	0,1 - 4	0,1 - 4	0,1 - 4
Feed per hand-wheel rotation X-axis	mm	0,5	2	2
Feed per scale division X-axis	mm	0,0025	0,0025	0,0025
Headstock				
Working headstock swivel range	deg	0 - 45	0 - 45	0 - 45
Working spindle taper	MT	4	4	4
Grinding headstock				
Grinding spindle speed	1/min	1.670	1.670	1.670
Grinding headstock swivel range (r+l)		10°	30°	30°
Inside grinding spindle speed	1/min	10.000	10.000	10.000
Tailstock				
Tailstock taper	MT	4	4	4
Tailstock quill stroke	mm	25	25	25
Drive capacity				
Motor rating - grinding spindle / hydraulic pump	kW	5,5 / 0,75	5,5 / 0,75	5,5 / 0,75
Motor rating inside grinding	kW	1,1	1,1	1,1
Motor rating - headstock / coolant pump	kW	0,75 / 0,13	1,5 / 0,125	1,5 / 0,125
Measures and weights				
Grinding wheel dimensions	mm	400x50x203	400x50x203	400x50x203
Grindstone dimensions, inside grinding (max.)	mm	50x40x16	50x40x16	50x40x16
Grindstone dimensions, inside grinding (min.)	mm	45x35x10	45x35x10	45x35x10
Overall dimensions (l x w x h)	m	3x1,8x1,65	3,61x1,81x1,52	4,61x1,81x1,52
Weight	kg	3.500	3.700	4.300
Part No.		302444	302445	302446

Conventional Cylindrical Grinding Machines

RSM A Series



The hydraulic linear feed is infinitely variable and micro-adjustable

Inside and outside machining with manual feed on transverse axis

- Internal and external grinding
- Hydrostatic bearings for high surface quality
- Swiveling headstock for conical grinding of short parts
- Integrated rapid feed on Z-axis with manual return
- Extensive package of standard accessories

STANDARD EQUIPMENT

- | | |
|---------------------------------------|-------------------------|
| ✓ 2-axis position indicator X.Pos 3.2 | ✓ Coolant system |
| ✓ Internal grinding equipment | ✓ Open rest |
| ✓ 3-jaw chuck Ø 200 mm | ✓ Closed rest |
| ✓ Chuck flange | ✓ Drivers |
| ✓ Balancing station | ✓ Work lamp |
| ✓ Balancing mandrel | ✓ Operating tools |
| ✓ Dress equipment | ✓ Operator instructions |
| ✓ Center point | |
| ✓ Grinding wheel flange | |



INFO



VIDEO

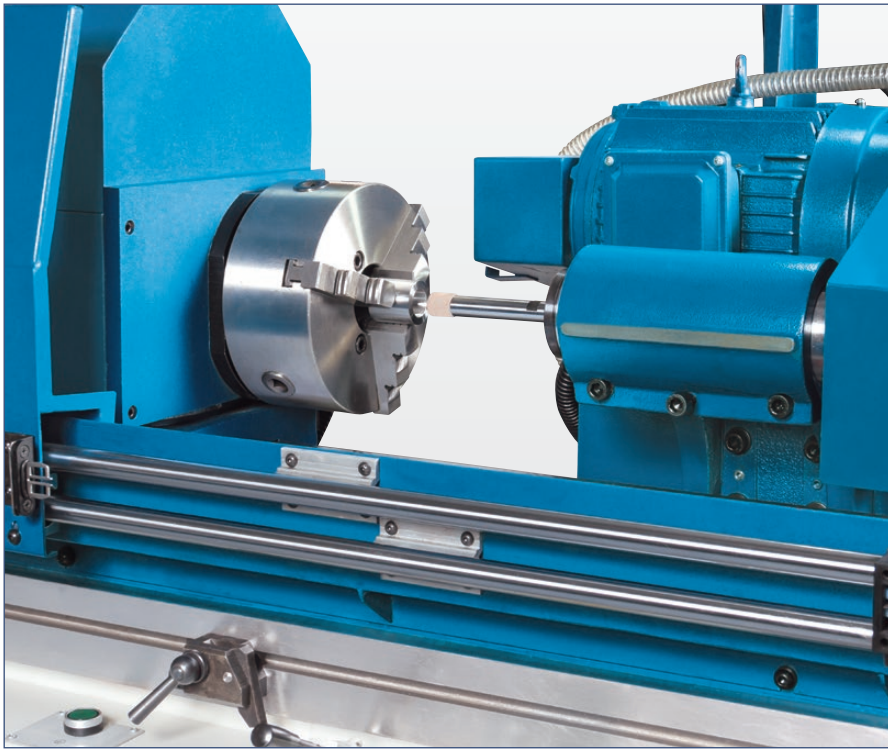

Grinding headstock can be rotated 180° to change from inside to outside grinding

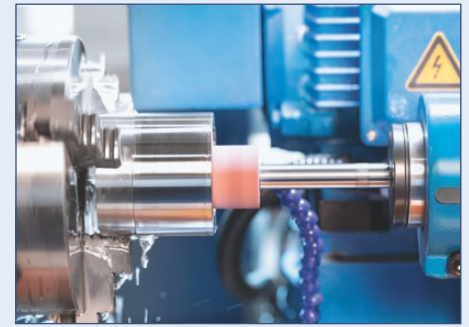

Allows inside grinding depths up to 125 mm

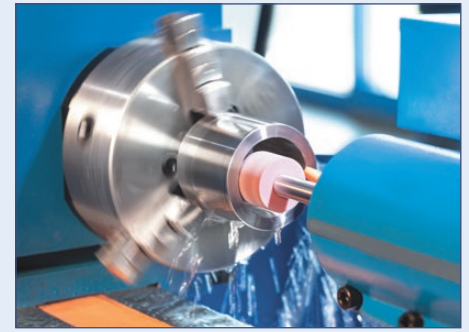

The maximum inside grinding diameter is 100 mm

SPECIFICATIONS

Machine model numbers		RSM 500 A	RSM 800
Working area			
Center height	mm	135	135
Workpiece length (max.)	mm	540	850
Grinding length	mm	500	800
Grinding diameter	mm	8 - 200	8 - 200
Inside grinding diameter without rest	mm	25 - 100	25 - 100
Workpiece weight between centers (max.)	kg	50	50
Inside grinding depth	mm	125	125
Table swivel range (max.)	R / L	-3° / +9°	-3° / +7°
Wheel speeds	m/s	38	35
Feed			
Table feed, infinitely variable	m/min	0,1 - 4	0,1 - 4
Feed per scale division X-axis	mm	0,005	0,005
Headstock			
Work spindle speeds	1/min	25 - 380	
Working headstock swivel range		0-45°	0-45°
Spindle taper	MT	4	4
Grinding headstock			
Inside grinding spindle speed	1/min	16.000	16.000
Grinding headstock swivel range (r+l)		± 30°	± 30°
Tailstock			
Tailstock taper	MT	4	4
Drive capacity			
Total power consumption	kVA	5,625	5,625
Measures and weights			
Grinding wheel dimensions	mm	400x50x203	400x50x203
Grindstone dimensions, inside grinding (max.)	mm	50x40x16	50x40x16
Grindstone dimensions, inside grinding (min.)	mm	45x35x10	35x45x10
Overall dimensions (L x w x h)	m	2,5x1,6x1,5	3x1,6x1,5
Weight	kg	2.500	3.000
Part No.		302430	370150

Tool Grinders

Multi Grind



Rigid angle-adjustable workpiece mounts

Multifunctional machine with inner and outer grinding device, ideal for sharpening tools and light grinding work

- Outer and inner cylindrical grinding
- Surface grinding
- Tool grinding
- Hydraulic table feed
- Wide range of accessories

STANDARD EQUIPMENT

- ✓ Coolant system
- ✓ Exhaust vacuum
- ✓ Tool mount / indexing head MT 4
- ✓ Internal grinding unit including 2 die grinders
- ✓ 3-jaw chuck Ø 100 mm
- ✓ Left tailstock
- ✓ Right tailstock MT 2
- ✓ Center point
- ✓ Half center points
- ✓ Balancing station
- ✓ Spindle extension
- ✓ Vise for surface grinding (3-D angle adjustment)
- ✓ Spring stop
- ✓ 5 drivers
- ✓ Various splash guards
- ✓ Grinding wheel guard (2x)
- ✓ Automatic central lubrication
- ✓ Abnahmeprotokoll
- ✓ Operator manual



INFO



VIDEO

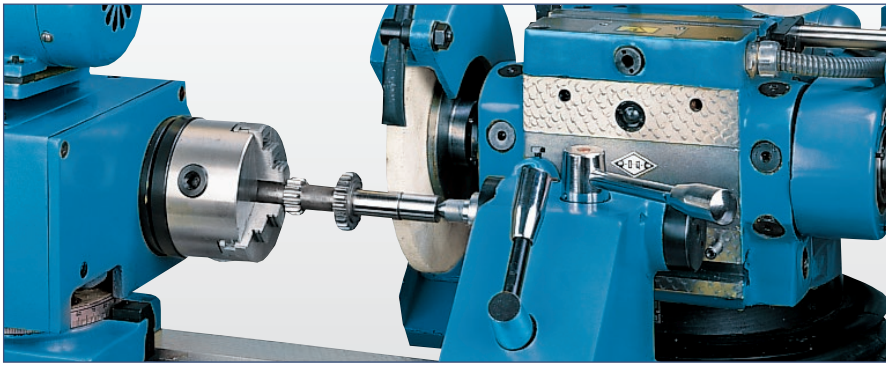

Outside cylindrical grinding for lengths up to 400 mm

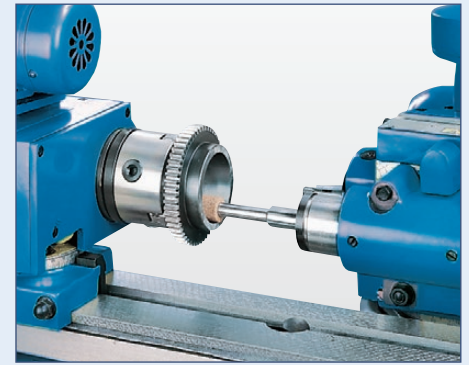

High-speed inside cylindrical grinding

SPECIFICATIONS		
Machine model numbers		Multi Grind
Working area		
Grinding diameter	mm	200
Workpiece length (max.)	mm	500
Outside grinding measure, maximum	mm	Ø 5-50 x 400
Inside grinding measures, optimal	mm	Ø 10-50 x 75
Tool grinding measure	mm	200x500
Workpiece length surface grinding	mm	200
Workpiece width surface grinding	mm	50
Workpiece weight (max.)	kg	10
Table swivel range (max.)		+45° / -30°
Travels		
Travel Z-axis	mm	480
Feed		
Feed per hand-wheel rotation X-axis, fine	mm	1
Feed per hand-wheel rotation X-axis, rough	mm	4
Feed per scale division X-axis, fine	mm	0,005
Feed per scale division, X-axis, rough	mm	0,02
Scale division of height adjustment	mm	0,01
Longitudinal feed speed (hydraulic)	m/min	0,1 - 6
Manual, hydraulic assist	m/min	7
Headstock		
Working headstock swivel range		± 90°
Working spindle speed	1/min	(3) 110 - 300
Working spindle taper	MK	2
Chuck diameter	mm	100
Grinding headstock		
Grinding spindle speed	1/min	2.500
Inside grinding spindle speed	1/min	13.500
Grinding headstock swivel range		± 90°
Grinding headstock - vertical / - transverse	mm	200
Tailstock		
Height adjustment per handwheel rotation	mm	2
Tailstock taper	MT	2
Tailstock quill stroke	mm	14
Drive capacity		
Machine drive capacity	kW	2,525
Motor rating main drive	kW	1,1
Measures and weights		
Grinding wheel dimensions	mm	200x20x75
Grindstone dimensions, inside grinding (min.)	mm	10x10x3
Grindstone dimensions, inside grinding (max.)	mm	25x20x6
Overall dimensions (L x w x h)	m	1,52x1,35x1,4
Weight	kg	1.300
Part No.		102781

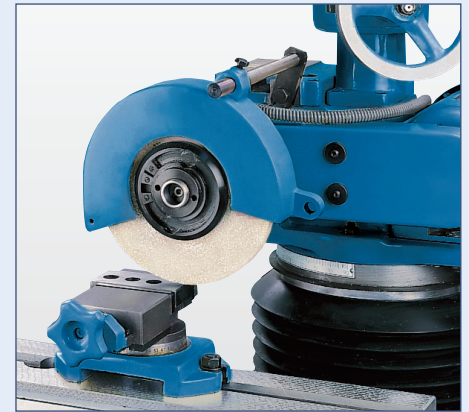

Surface grinding with angle-adjustable vise

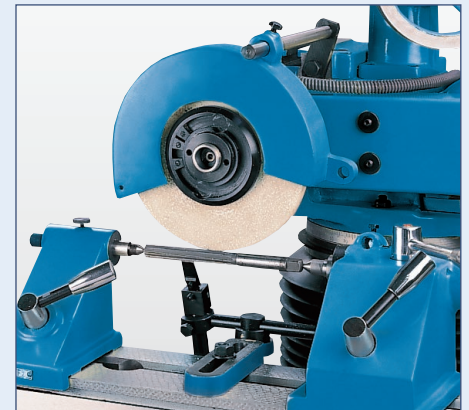

Swiveling headstock and extensive accessories

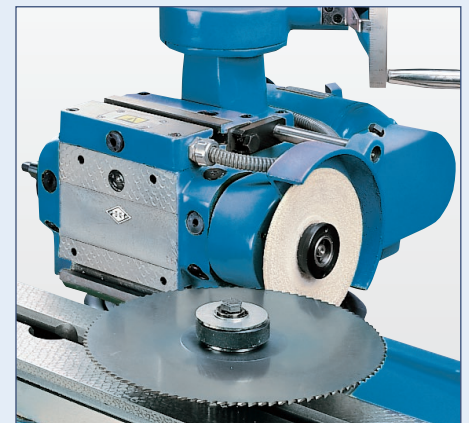

Saw blade sharpening

Conventional Surface Grinding Machines

HFS F NC Series



Fig. incl. optional accessories



The position indicator is integrated in the control panel

Moving column design with automated control of X and Z axes and Siemens HMI

- Moving column design for maximum stability
- Magnetic clamping plate with built-in demagnetizing function
- Siemens Smart Line PLC control with grinding cycles
- NC-controlled Y/Z axes driven by servo motors
- User-friendly HMI with touchscreen
- Electronic handwheel for Y/Z axes

STANDARD EQUIPMENT

- | | |
|---|---------------------------------|
| ✓ 2-axis position indicator X.Pos 3.2 | ✓ Balancing shaft |
| ✓ Siemens PLC-control with Touchscreen | ✓ LED work lamp |
| ✓ Electronic Handwheel for Y Z Axis | ✓ Magnetic clamping plate |
| ✓ Grinding wheel flange | ✓ Adjustment screws |
| ✓ Workspace enclosure | ✓ Grinding wheel |
| ✓ Coolant system | ✓ Automatic central lubrication |
| ✓ Diamond dresser stand (without diamond) | ✓ Operating tools |
| ✓ Balancing station | ✓ Operator manual |





The workspace is protected by an easily accessible enclosure

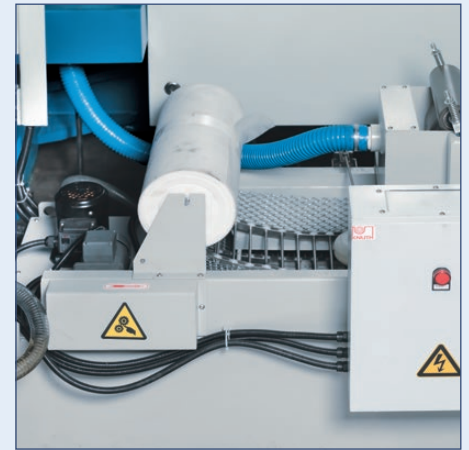

The coolant system can be equipped with an optional magnetic separator and filter

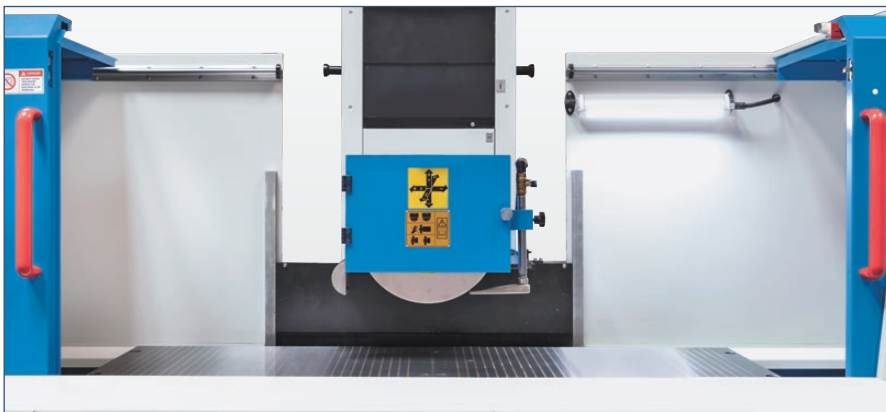

Wide opening doors are provided for easy loading and unloading



On the moving column design, the grinder table travels directly on the wide machine bed

SPECIFICATIONS

Machine model numbers		50100	50160	60160	60200
Working area					
Table dimensions	mm	500x1.000	500x1.600	600x1.600	600x2.200
Spindle center-to-table distance	mm	600	600	600	600
Table load capacity (max.)	kg	700	900	1.300	1.690
Magnetic chuck height	mm	110	110	110	110
Travels					
Travel X-axis	mm	1.000	1.600	1.600	2.200
Travel Y-axis	mm	500	500	630	630
Feed					
Hydr. feed X-axis	m/min	5 - 25	5 - 25	5 - 25	5 - 25
Feed Y-axis	mm/min	50 - 500	50 - 500	50 - 500	50 - 500
Feed depth, Y-axis	mm	0,005 - 0,05	0,005 - 0,05	0,005 - 0,05	0,005 - 0,05
Feed Z-axis	mm/min	50 - 1.500	50 - 1.500	50 - 1.500	50 - 1.500
Automatic Z-axis feed	mm/min	0 - 30	0 - 30	0 - 30	0 - 30
Grinding wheel					
Grinding wheels dimensions	mm	350x40x127	350x40x127	350x40x127	350x40x127
Speed	1/min	1.450	1.450	1.450	1.450
Drive capacity					
Motor rating main drive	kW	7,5	7,5	7,5	7,5
Hydraulic motor rating	kW	3	3	5,5	5,5
Y-axis servo motor	kW	2	2	2	2
Z-axis servo motor	kW	0,5	0,5	0,5	0,5
Measures and weights					
Overall dimensions (L x w x h)	m	4,5x2,65x2,7	6,01x2,5x2,7	5,5x2,75x2,7	6,5x2,75x2,7
Weight	kg	5.500	6.000	7.000	8.000
Part No.		124934	124935	124936	124937

Conventional Surface Grinding Machines

HFS F Advance Series



If set to Auto mode, the user-defined roughing and finishing parameters, number of spark-out strokes, and return to zero are automatically processed



Surface grinders with automated control of Z axis and Siemens HMI

- Magnetic clamping plate with built-in demagnetizing function
- Vertical axis with ballscrew and servo motor for high precision
- Easy auto-mode programming with Siemens PLC and touchscreen
- Extensive standard equipment package

STANDARD EQUIPMENT

- ✓ 2-axis position indicator X.Pos 3.2
- ✓ Siemens PLC-control with Touchscreen
- ✓ Electronic hand-wheel
- ✓ Grinding wheel flange
- ✓ Automatic central lubrication
- ✓ Workspace enclosure
- ✓ Coolant and suction device
- ✓ Grinding wheel dresser
- ✓ Balancing station
- ✓ Balancing shaft
- ✓ LED work lamp
- ✓ Magnetic clamping plate
- ✓ Adjustment screws
- ✓ Demagnetization unit
- ✓ Grinding wheel
- ✓ Operating tools
- ✓ Operator manual



If set to Auto mode, the user-defined roughing and finishing parameters, number of spark-out strokes, and return to zero are automatically processed



Dressing gives the grinding wheel precise concentricity and a correct geometric shape

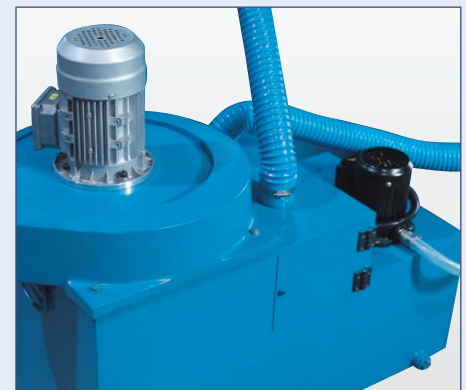

A coolant system and vacuum exhaust are standard accessories

SPECIFICATIONS

Machine model numbers		2550 F	3063 F	4080 F	30100 F	40100 F
Working area						
Workpiece weight (max.)	kg	180	270	500	400	600
Spindle nose-to-table surface distance	mm	450	580	580	580	580
Table dimensions	mm	508x254	635x305	813x406	1.020x300	1.020x406
Dimensions magnetic clamping plate	mm	500x250	600x300	800x400	1.000x300	1.000x400
Scale ring division Y-axis	mm	0,005	0,005	0,005	0,005	0,005
Scale ring division Z-axis	mm	0,02	0,02	0,02	0,02	0,02
Autom. transverse feed Z-axis	mm	0,1 - 8	0,1 - 8	0,1 - 8	0,1 - 8	0,1 - 8
Speed	1/min	2.850	1.450	1.450	1.450	1.450
Autom. vertical feed	mm	0,005 - 0,05	0,005 - 0,05	0,005 - 0,05	0,005 - 0,05	0,005 - 0,05
Travels						
Travel X-axis	mm	560	765	910	1.130	1.130
Travel Y-axis	mm	275	340	450	340	450
Feed						
Hydr. feed X-axis	m/min	5 - 25	7 - 23	7 - 23	7 - 23	7 - 23
Rapid feed Y-axis	mm/min	480	480	480	480	480
Rapid feed Z-axis	mm/min	790	990	990	990	990
Drive capacity						
Motor rating main drive	kW	2,2	4	4	4	4
Measures and weights						
Grinding wheel dimensions	mm	200x20x31,75	350x40x127	350x40x127	350x40x127	350x40x127
Overall dimensions (l x w x h)	m	2,3x1,6x1,68	2,9x2,2x1,9	3,6x2,4x1,9	4,4x2,2x1,9	4,4x2,4x1,9
Weight	kg	1.800	2.800	3.400	3.200	3.700
Part No.		124931	124932	124933	124941	124930



Permanent magnetic clamping plates with micro polepitch - ideal for high-precision grinding work

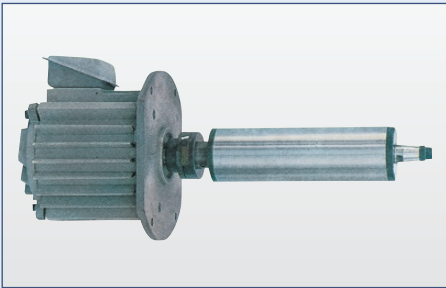

Main spindle drive with advanced precision bearing

STANDARD EQUIPMENT

- ✓ Exhaust vacuum
- ✓ Work lamp
- ✓ Magnetic clamping plate 125 x 300 mm
- ✓ Balancing shaft
- ✓ Balancing station
- ✓ Angle - adjustable grinding vise
- ✓ Grinding wheel flange
- ✓ Grinding wheel dresser
- ✓ Grinding wheel
- ✓ Operating tools
- ✓ Operator manual



INFO

Conventional Surface Grinding Machines FSM 480



Ideal grinder featuring many standard features for workshop applications

- Cast-iron machine base absorbs vibrations
- Magnetic clamping plate 125 x 300 mm
- Extensive standard equipment included
- Angle-adjustable grinding vise

SPECIFICATIONS

Machine model numbers	FSM 480	
Working area		
Table dimensions	mm	210x450
Spindle axis-to-table surface distance	mm	450
Travels		
Travel X-axis	mm	480
Travel Y-axis	mm	230
Travel distance per hand-wheel rotation, X-axis	mm	5
Travel distance per hand-wheel rotation, Y-axis	mm	5
Travel distance per hand-wheel rotation, Z-axis	mm	1
Feed		
Scale ring division X-axis	mm	0,02
Scale ring division Y-axis	mm	0,02
Scale ring division Z-axis	mm	0,005
Accuracies		
Roughness	µm Ra	>= 0,63
Drive capacity		
Motor rating main drive	kW	1,5
Measures and weights		
Grinding wheel dimensions	mm	200x13x32
Weight	kg	730
Part No.		122802

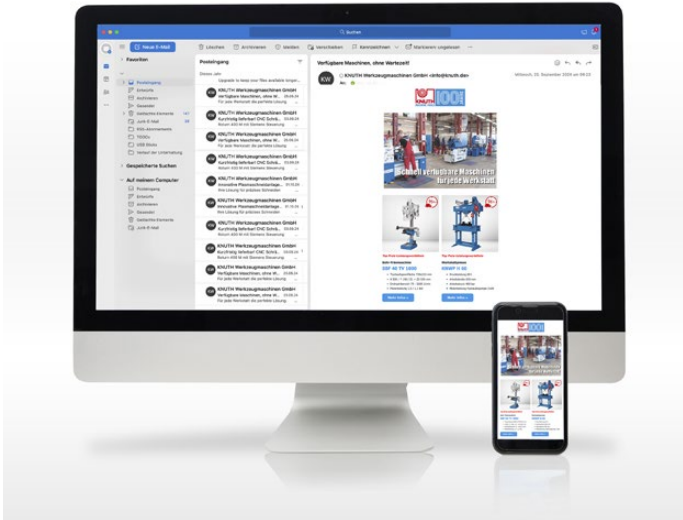

KNUTH Newsletter

Stay one step ahead.
Subscribe to our newsletter now!

Get exclusive insights and the latest offers – delivered straight to your inbox.

Never miss a special promotion!

Subscribe now!



KNUTH on YouTube

KNUTH machines in action

On our YouTube channel, you'll find videos for nearly every machine in our product range. We showcase machines from current deliveries, giving you insight into their handling, build quality, and machining performance.

Interested in a machine but can't find a recent video?

Feel free to contact us!



KNUTH on Instagram

Have you seen our Instagram account yet?

We regularly post interesting content, news, and updates about our products and services.

Stay up to date and follow us on Instagram.

We look forward to connecting with you!

FOLLOW US

→





Case Studies

From small family businesses to globally recognized industrial companies – behind every successful production, there are powerful machines.

In our user stories, you'll discover how we work with our customers to develop customized solutions and how these prove themselves in daily production.

**Success firsthand.
Get inspired!**



The Entire World of Metalworking

More KNUTH Topic Catalogs:

Cutting Technologies

We present state-of-the-art cutting technologies under one roof: laser and plasma cutting.

CNC Machining

Solutions for your production. Turning, milling, drilling, sawing, and grinding with modern technology.

Sheet Metal Processing

Machines for flexible sheet and tube processing. In addition to press brakes and guillotine shears, we showcase folding and roll bending machines as well as hydraulic presses.

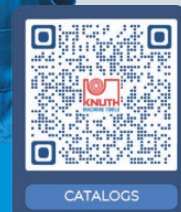

Simply request it here:

Visit KNUTH Machine Tools!

At our locations in **Wasbek**, **Denkendorf** and **Bocholt**, we present machines and technologies covering the full spectrum of metalworking.

Headquarter

Schmalenbrook 14
24647 Wasbek / Neumünster
Tel. +49 (0) 4321 - 609-0
info@knuth.de

Demonstration Centre South

Alemannenstr. 19
85095 Denkendorf / Ingolstadt
Tel. +49 (0) 8466 9419-0
verkauf-sued@knuth.de

Showroom West

Prinzenstraße 2
46399 Bocholt
Tel. +49 (0) 15150966157
verkauf-west@knuth.de